

HI97700

Ammonia Low Range Photometer



INSTRUCTION MANUAL

Dear
Customer,

Thank you for choosing a Hanna Instruments product.

Please read this instruction manual carefully before using the instrument.

This manual will provide you with the necessary information for correct use of the instrument, as well as a precise idea of its versatility.

If you need additional technical information, do not hesitate to e-mail us at tech@hannainst.com or view our worldwide contact list at www.hannainst.com.

All rights are reserved. Reproduction in whole or in part is prohibited without the written consent of the copyright owner, Hanna Instruments Inc., Woonsocket, Rhode Island, 02895, USA.

1. PRELIMINARY EXAMINATION	4
2. SAFETY MEASURES	4
3. SPECIFICATIONS	5
4. ABBREVIATIONS	5
5. DESCRIPTION	6
5.1. GENERAL DESCRIPTION AND INTENDED USE	6
5.2. FUNCTIONAL DESCRIPTION	7
5.3. PRECISION AND ACCURACY	8
5.4. PRINCIPLE OF OPERATION	8
5.5. OPTICAL SYSTEM	9
6. GENERAL OPERATIONS	9
6.1. METER VALIDATION: CAL CHECK / CALIBRATION	9
6.2. CHEMICAL FORMULA / UNIT CONVERSION	11
6.3. GLP	11
6.4. LOGGING DATA/LOG RECALL	11
6.5. GENERAL SETUP	12
6.6. REAGENTS/ACCESSORIES	14
6.7. CONTEXTUAL HELP	15
6.8. BATTERY MANAGEMENT	15
7. PHOTOMETER	15
7.1. PROPER USE OF DROPPER BOTTLE	15
7.2. CUVETTE PREPARATION	16
8. METHOD PROCEDURE	17
9. ERROR DESCRIPTIONS	20
10. BATTERY REPLACEMENT	21
11. ACCESSORIES	22
11.1. REAGENT SETS	22
11.2. OTHER ACCESSORIES	22
CERTIFICATION	23
RECOMMENDATIONS FOR USERS	23
WARRANTY	23

1. PRELIMINARY EXAMINATION

Remove the instrument and accessories from the packaging and examine it carefully to make sure that no damage has occurred during shipping. Notify your nearest Hanna Customer Service Center if damage is observed.

Each **HI97700C** is delivered in a rugged carrying case and is supplied with:

- Sample cuvette (2 pcs.)
- Sample cuvette cap (2 pcs.)
- Plastic stopper (2 pcs.)
- **A ZERO** - CAL Check Cuvette A
- **HI97700B** - CAL Check Cuvette B for Ammonia LR
- Cloth for wiping cuvettes
- 1.5V AA Alkaline batteries
- Instruction manual
- Meter quality certificate
- CAL Check standard certificate

Each **HI97700** is delivered in a cardboard box and is supplied with:

- Sample cuvette (2 pcs.)
- Sample cuvette cap (2 pcs.)
- Plastic stopper (2 pcs.)
- 1.5V AA Alkaline batteries
- Instruction manual
- Meter quality certificate

Note: Save all packing material until you are sure that the instrument works correctly. Any damaged or defective item must be returned in its original packing material with the supplied accessories.

2. SAFETY MEASURES



- The chemicals contained in the reagent kits may be hazardous if improperly handled.
- Read the Safety Data Sheets (SDS) before performing tests.
- Safety equipment: Wear suitable eye protection and clothing when required, and follow instructions carefully.
- Reagent spills: If a reagent spill occurs, wipe up immediately and rinse with plenty of water. If reagent contacts skin, rinse the affected area thoroughly with water. Avoid breathing released vapors.
- Waste disposal: For proper disposal of reagent kits and reacted samples, contact a licensed waste disposal provider.

3. SPECIFICATIONS

Ammonia Low Range	Range	0.00 to 3.00 mg/L (as NH ₃ -N)
	Resolution	0.01 mg/L
	Accuracy	±0.04 mg/L ± 4% of reading at 25 °C
	Method	Adaptation of ASTM Manual of Water and Environmental Technology, D1426 Nessler method
Measurement System	Light source	Light Emitting Diode
	Bandpass filter	420 nm
	Bandpass filter bandwidth	8 nm
	Bandpass filter wavelength accuracy	± 1.0 nm
	Light detector	Silicon photocell
	Cuvette type	Round 24.6 mm diameter (22 mm inside)
Additional Specifications	Auto logging	50 readings
	Display	128 x 64 pixel B/W LCD with backlight
	Auto-off	After 15 minutes of inactivity (30 minutes before a READ measurement)
	Battery type	1.5 V AA Alkaline (3 pcs.)
	Battery life	> 800 measurements (without backlight)
	Environment	0 to 50 °C (32 to 122 °F); 0 to 100% RH, non-serviceable
	Dimensions	142.5 x 102.5 x 50.5 mm (5.6 x 4.0 x 2.0")
	Weight (with batteries)	380 g (13.4 oz.)
	Case ingress protection rating	IP67, floating case

4. ABBREVIATIONS

mg/L	milligrams per liter (ppm)
mL	milliliter
°C	degree Celsius
°F	degree Fahrenheit
LED	Light Emitting Diode
HDPE	High Density Polyethylene
GLP	Good Laboratory Practice
NIST	National Institute of Standards and Technology

5. DESCRIPTION

5.1. GENERAL DESCRIPTION AND INTENDED USE

The **HI97700** is an auto-diagnostic portable meter that benefits from Hanna's years of experience as a manufacturer of analytical instruments. It has an advanced optical system that uses a Light Emitting Diode (LED) and a narrow band interference filter that allows for accurate and repeatable readings.

The optical system is sealed from outside dust, dirt and water. The meter uses an exclusive positive-locking system to ensure that the cuvettes are placed into the holder in the same position every time.

With the CAL Check functionality, users are able to validate the performance of the instrument at any time and apply a user calibration (if necessary). Hanna's CAL Check cuvettes are made with NIST traceable standards.

The built-in tutorial mode guides users step-by-step through the measurement process. It includes all steps required for sample preparation, the required reagents and quantities.

The **HI97700** meter measures ammonia in water samples from 0.00 to 3.00 mg/L (ppm). The method is an adaptation of ASTM Manual of Water and Environmental Technology, D1426 Nessler method.

Ammonia is an indication of animal and/or plant decay. It is one of the important pollutants monitored in natural water due to its toxicity.

The **HI97700** photometer is a compact and versatile meter suitable for field or bench measurements, featuring a:

- Sophisticated optical system
- Meter validation using certified CAL Check cuvettes
- Tutorial mode guides the user step-by-step
- Auto logging
- Waterproof IP67, floating case
- GLP features



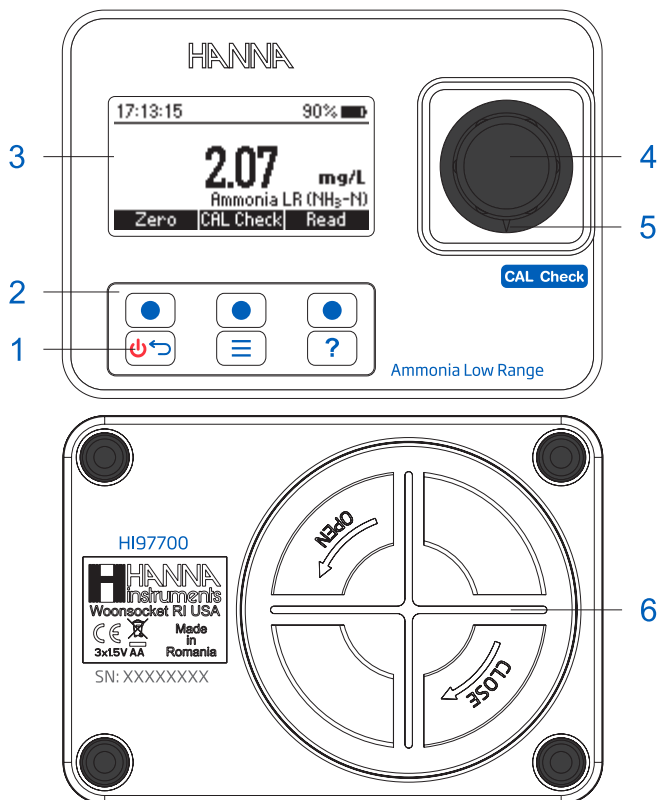

5.2. FUNCTIONAL DESCRIPTION



- | | | |
|------------------------|---------------------------------|------------------|
| 1) ON/OFF power button | 3) Liquid Crystal Display (LCD) | 5) Indexing mark |
| 2) Keypad | 4) Cuvette holder | 6) Battery cover |

Keypad Description

The keypad contains 3 direct keys and 3 functional keys with the following functions:

-  Press the functional keys to perform the function displayed above them on the LCD.
-  Press and hold to power off/on. Press briefly to return to the previous screen.
-  Press to access the menu screen.
-  Press to display the context-sensitive help menu.

5.3. PRECISION AND ACCURACY

Precision is how closely repeated measurements are to one another.

Precision is usually expressed as standard deviation (SD).

Accuracy is defined as the closeness of a test result to the true value.

Although good precision suggests good accuracy, precise results can be inaccurate. The figure explains these definitions.

For each method, the accuracy is expressed in the related measurement section.

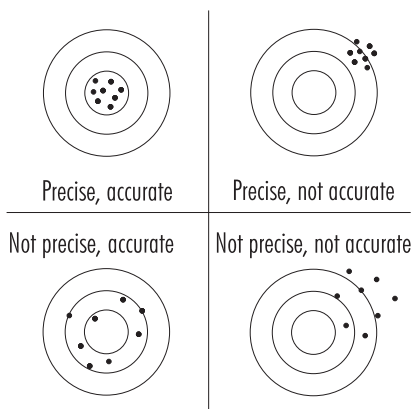

5.4. PRINCIPLE OF OPERATION

Absorption of light is a typical phenomenon of interaction between electromagnetic radiation and matter. When a light beam crosses a substance, some of the radiation may be absorbed by atoms, molecules or crystal lattices.

If pure absorption occurs, the fraction of light absorbed depends both on the optical path length through the matter and on the physical-chemical characteristics of the substance according to the Lambert-Beer Law:

$$-\log I/I_o = \epsilon_{\lambda} c d$$

or

$$A = \epsilon_{\lambda} c d$$

- I_o = intensity of incident light beam
 I = intensity of light beam after absorption
 ϵ_{λ} = molar extinction coefficient at wavelength λ
 c = molar concentration of the substance
 d = optical path through the substance

Therefore, the concentration "c" can be calculated from the absorbance of the substance as the other factors are constant.

Photometric chemical analysis is based on specific chemical reactions between a sample and reagent to produce a light-absorbing compound.

5.5. OPTICAL SYSTEM

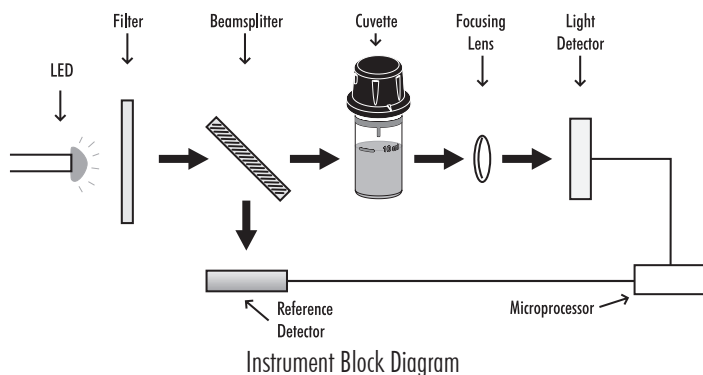

The internal reference system (reference detector) of the [HI97700](#) photometer compensates for any drifts due to power fluctuations or ambient temperature changes, providing a stable source of light for your blank (zero) measurement and sample measurement.

LED light sources offer superior performance compared to tungsten lamps. LEDs have a much higher luminous efficiency, providing more light while using less power. They also produce little heat, which could otherwise affect electronic stability. LEDs are available in a wide array of wavelengths, whereas tungsten lamps have poor blue/violet light output.

Improved optical filters ensure greater wavelength accuracy and allow a brighter, stronger signal to be received. The end result is higher measurement stability and less wavelength error.

A focusing lens collects all of the light that exits the cuvette, eliminating errors from cuvette imperfections and scratches, eliminating the need to index the cuvette.

6. GENERAL OPERATIONS

6.1. METER VALIDATION: CAL CHECK / CALIBRATION

Validation of the [HI97700](#) involves verifying the concentration of the certified CAL Check standards. The CAL Check screen guides the user step-by-step through the validation process and user calibration (if necessary).

WARNING: Do not use any solutions/standards other than the Hanna® CAL Check Standards. For accurate validation and calibration results, please perform these at room temperature (18 to 25 °C; 64.5 to 77.0 °F).

Note: CAL Check Standards will not read the specified value in measurement mode. Protect the CAL Check cuvettes from direct sunlight by keeping them in the original packing. Store between +5 °C and +30 °C (41 - 86 °F), do not freeze.

To perform a CAL Check:

1. Press **CAL Check** key from measurement mode.
The “**Not Available**” message or the date/time and status of the last CAL Check will be displayed on the screen.
2. Press the **Check** key to start a new CAL Check.
Press the  key at any time to abort the validation process.
3. Use the **▲ ▼** keys to enter the certificate value of the calibration standard found on the CAL Check Standard Certificate. Press **Next** to continue.

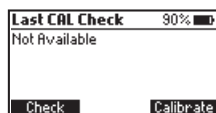
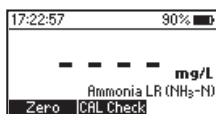

Note: This value will be saved in the instrument for future validation. If a new set of calibration standards is obtained please update the certificate value.

4. Insert the **A ZERO** CAL Check Cuvette A then press **Next** to continue. The “**Please Wait...**” message will be displayed during the measurement.
5. Insert the **HI97700B** CAL Check Cuvette B then press **Next** to continue. The “**Please Wait...**” message will be displayed during the measurement.
6. When the CAL Check is complete the display will show one of the following messages and the value obtained during the measurement:

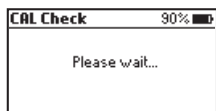

- “**PASSED**”: The measured value is within the accuracy specification, no user calibration is required.

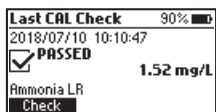

- “**OUT OF SPECIFICATION**” and the **Calibration** key is available: The measured value is near the expected value. To update the user calibration press **Calibrate**. Press **Accept** to confirm or **Cancel** to return to the previous screen.

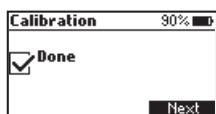
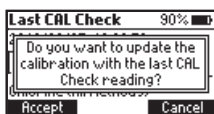
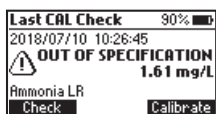

- “**OUT OF SPECIFICATION**”: A user calibration is not allowed, the measured value is outside of the tolerance window. Check the certified value, expiration date and clean the outside of the cuvette. Repeat the CAL Check procedure. If this error continues contact your nearest Hanna Customer Service Center.

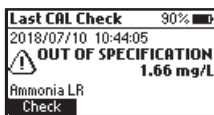

6.2. CHEMICAL FORMULA / UNIT CONVERSION

Chemical formula/unit conversion factors are pre-programmed into the instrument and are method specific. In order to view the displayed result in the desired chemical formula enter menu by pressing  and use the \blacktriangle \blacktriangledown keys to select **Chemical Form**. Press **Select** to change the displayed chemical form. Use the \blacktriangle \blacktriangledown keys to highlight the desired chemical formula and press **Select**. The selected formula will be saved when the instruments is powered off.

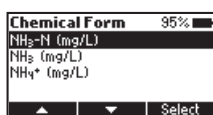

6.3. GLP

Press the  key to enter the menu. Use the \blacktriangle \blacktriangledown keys to select **GLP** and press **Select**. Good Laboratory Practice (GLP) shows the date and time of the last user calibration (if available) or factory calibration. To erase the last user calibration and to clear the CAL Check press **Clear** and follow the prompts. Press **Yes** to erase and return to the factory calibration data or **No** to exit the clear procedure.

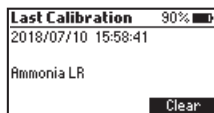

6.4. LOGGING DATA/LOG RECALL

The instrument features a data autolog function to help users keep track of all measurements. Every time a measurement is made the data is automatically saved. The data log can hold 50 individual measurements. When the data log is full (50 data points) the meter will rewrite the oldest data point.

Viewing and deleting the data is possible using the **Log Recall** menu.

Press the  key to enter the menu. Use the functional \blacktriangle \blacktriangledown keys to select **Log Recall** and press **Select**.



Use the functional **▲ ▼** keys to highlight a log and press **Info** to view additional information about the log. From this screen the **Next** and **Previous** keys can be used to view other logs.

Log Recall			3/7	90%
07/11	1.96 mg/L	NH ₄ ⁺		
07/11	1.85 mg/L	NH ₃		
07/11	1.52 mg/L	NH ₃ -N		
07/11	1.52 mg/L	NH ₃ -N		

Log Recall			90%
1.52 mg/L NH ₃ -N			
Ammonia LR			
2018/07/11 15:53:22			
Delete	Previous	Next	

Use the **Delete** key to erase logged data. After pressing **Delete** a prompt on display is asking for confirmation.

Log Recall			90%
1.52 mg/L NH ₃ -N			
Do you want to delete the selected log?			
No	Yes	Del All	

Log Recall			90%
1.52 mg/L NH ₃ -N			
Do you want to delete all logs?			
No	Yes		

Press **No** or the  key to return to the previous screen.

Press **Yes** to delete selected log.

Press **Del All** to erase all the logged data.

If **Del All** is pressed follow the prompt to confirm.

Press **Yes** to delete all logged data, **No** or the  key to return to the log recall.

6.5. GENERAL SETUP

Press the  key to enter the menu. Use the **▲ ▼** keys to select **Setup** and press **Select**. Use the **▲ ▼** keys to highlight desired option.

Backlight

Values: 0 to 100 %

Press the **Modify** key to access the backlight intensity.

Use the **◀ ▶** keys to increase or decrease the value.

Press the **Accept** key to confirm or the  key to return to the **Setup** menu without saving the new value.

Setup			95%
Backlight	50%		
Contrast	50%		
Date / Time	17:27:54		
Time Format	24-hour		

Backlight			95%
0% ██████████ 100%			
50%			
◀	▶	Accept	

Contrast

Values: 0 to 100 %

Press the **Modify** key to change the display's contrast.

Use the **◀ ▶** keys to increase or decrease the value.

Press the **Accept** key to confirm the value or the  key to return to the **Setup** menu without saving the new value.

Setup			95%
Backlight	50%		
Contrast	50%		
Date / Time	17:28:23		
Time Format	24-hour		

Contrast			95%
0% ██████████ 100%			
50%			
◀	▶	Accept	

Date / Time

Press the **Modify** key to change the date/time.

Press the ◀ ▶ keys to highlight the value to be modified (year, month, day, hour, minute or second).

Press **Edit** to modify the highlighted value. Use the ▲ ▼ keys to change the value.

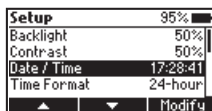

Press the **Accept** key to confirm or the  key to return to the previous screen.



Time Format

Option: AM/PM or 24-hour Press the functional key to select the desired time format.

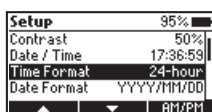

Date Format

Press the **Modify** key to change the date format.

Use the ▲ ▼ keys to select the desired format.

Press the **Accept** key to confirm or the  key to return to the *Setup* menu without saving the new format.

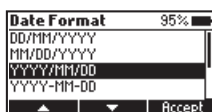
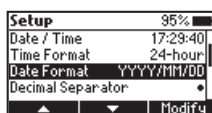

Decimal Separator

Option: Comma (,) or Period (.)

Press the functional key to select the desired decimal separator. The decimal separator is used on the measurement screen.

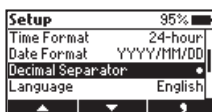

Language

Press the **Modify** key to change the language. Use the ▲ ▼ keys to select the desired language.

Press **Accept** to choose one of the languages installed.

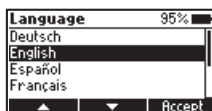
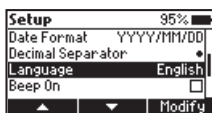

Beeper

Option: Enable or Disable

When enabled, a short beep is heard every time a key is pressed. A long beep alert sounds when the pressed key is not active or an error is detected. Press the functional key to enable/disable the beeper.

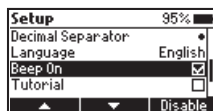

Tutorial

Option: Enable or Disable

When enabled, the user will be guided step-by-step through the measurement procedure.

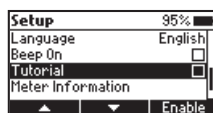

Meter Information

Press the **Select** key to view the model, serial number, firmware version and selected language. Press the  key to return to the *Setup* menu.

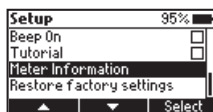



Restore factory settings

Press the **Select** key to reset to factory settings.

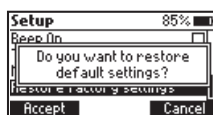
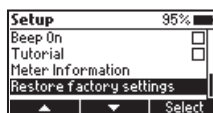
Press **Accept** to confirm or **Cancel** to exit without restoring the factory settings.



6.6. REAGENTS/ACCESSORIES



Press the  key to enter the menu. Use the ▲ ▼ keys to select *Reagents/Accessories* and press **Select** to access a list of reagents and accessories. To exit press the  key.



6.7. CONTEXTUAL HELP

The HI97700 offers an interactive contextual help mode that assists the user at any time.

To access the help screen press the  key.

The instrument will display additional information related to the current screen. To read all the available information, scroll the text using the   keys.

To exit help mode press the  or the  key and the meter will return to the previous screen.

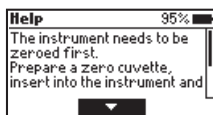

6.8. BATTERY MANAGEMENT

The meter will perform an auto-diagnostic test when it is powered on. During this test, the Hanna® logo will appear on the LCD. After 5 seconds, if the test was successful, the last method selected will appear on the display. The battery icon on the LCD will indicate the battery status:

- battery full

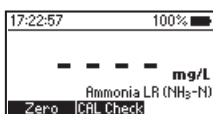

- battery below 10%, replace the batteries soon

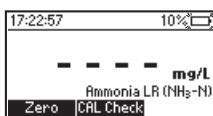

- battery is low, replace the batteries with new ones

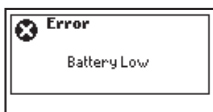

To conserve battery, the meter will turn off automatically after 15 minutes of inactivity. If a zero reading has been done but not a read, auto-off time is increased to 30 minutes.

7. PHOTOMETER

7.1. PROPER USE OF DROPPER BOTTLE

(a) For reproducible results, tap the dropper on the table several times and wipe the outside of the tip with a cloth.

(b) Always keep the dropper bottle in a vertical position while dosing the reagent.

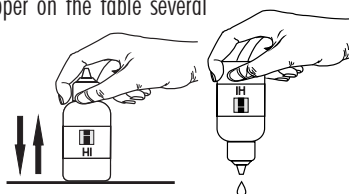



7.2. CUVETTE PREPARATION

Proper mixing is very important for reproducibility of the measurements.

Invert the cuvette a couple of times or for a specified time: hold the cuvette in the vertical position. Turn the cuvette upside-down and wait for all of the solution to flow to the cap end, then return the cuvette to the upright vertical position and wait for all of the solution to flow to the cuvette bottom. This is one inversion. The correct speed for this mixing technique is 10-15 complete inversions in 30 seconds.

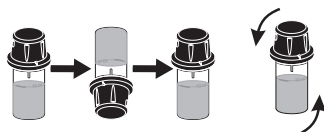
This mixing technique is indicated with “invert to mix” and the following icon:



In order to avoid reagent leaking and to obtain more accurate measurements, close the cuvette first with the supplied HDPE plastic stopper  and then the black cap.

Whenever the cuvette is placed into the measurement holder, it must be dry outside and free of fingerprints, oil or dirt. Wipe it thoroughly with [HI731318](#) or a lint-free cloth prior to insertion.

Shaking the cuvette can generate bubbles in the sample, causing higher readings. To obtain accurate measurements, remove such bubbles by swirling or by gently tapping the cuvette.

Do not let the reacted sample stand too long after reagent has been added. For best accuracy, respect the timings described in each specific method.

It is possible to take multiple readings in a row, but it is recommended to take a new zero reading for each sample and to use the same cuvette for zeroing and measurement when possible.

Discard the sample immediately after the reading has been taken, or the glass might become permanently stained.

All the reaction times reported in this manual are at 25 °C (77 °F). In general, the reaction time should be increased for temperatures lower than 20 °C (68 °F), and decreased for temperatures higher than 25 °C (77 °F).

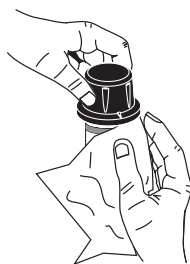

8. METHOD PROCEDURE

REQUIRED REAGENTS

Code	Description	Quantity
HI93700A-0	Ammonia Low Range Reagent A	4 drops
HI93700B-0	Ammonia Low Range Reagent B	4 drops

REAGENT SETS

HI93700-01 Ammonia LR Reagent - 100 tests

HI93700-03 Ammonia LR Reagent - 300 tests

For other accessories see page 22.

MEASUREMENT PROCEDURE

Note: If tutorial mode is disabled follow the measurement procedure below. If the tutorial mode is enabled, press **Measure** and follow the messages on the screen.

- Fill the cuvette with 10 mL of unreacted sample (up to the mark). Replace the plastic stopper and the cap.



- Insert the cuvette into the holder and ensure that the notch on the cap is positioned securely in the groove.

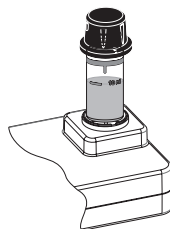

- Press the **Zero** key. The display will show “-0.0-” when the meter is zeroed and ready for measurement.

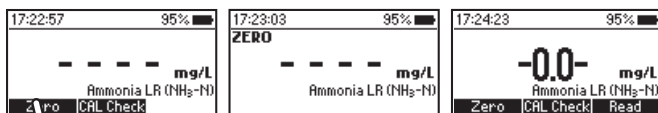

- Remove the cuvette.

- Add 4 drops of **HI93700A-0** Ammonia Low Range Reagent A. Replace the plastic stopper and the cap. Invert 5 times to mix.

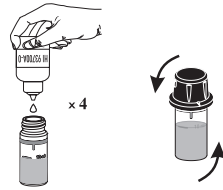

- Add 4 drops of **HI93700B-0** Ammonia Low Range Reagent B. Replace the plastic stopper and the cap. Invert 5 times to mix.

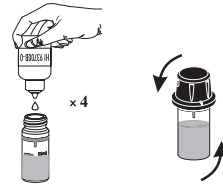

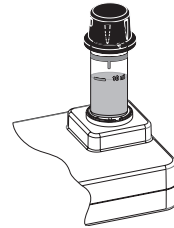

- Replace the cuvette into the holder and ensure that the notch on the cap is positioned securely in the groove.

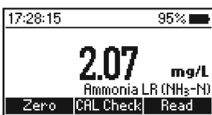

- Press the **Read** key and the display will show a 3 minute 30 second countdown prior to the measurement. To skip the timer press **Read** twice. When the timer ends the meter will perform the reading. The instrument displays the results in mg/L of ammonia nitrogen ($\text{NH}_3\text{-N}$).



- Press  and use the   keys to select **Chemical Form**.
- Press **Select** to change the displayed chemical form to **mg/L of ammonia (NH₃) and ammonium (NH₄⁺)**.

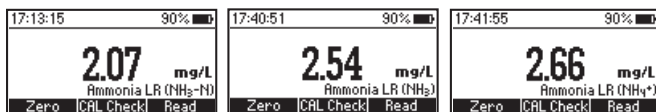
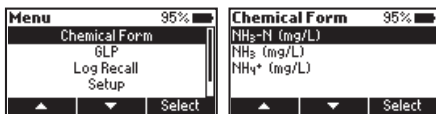

- Press  to return to the measurement screen.

INTERFERENCE

Interference may be caused by:

- Acetone
- Alcohols
- Aldehydes
- Glycine
- Hardness above 1 g/L
- Iron
- Organic chloramines
- Sulfide
- Various aliphatic and aromatic amines

9. ERROR DESCRIPTIONS

The instrument shows clear warning messages when erroneous conditions appear and when measured values are outside the expected range. These messages are described below.

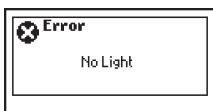

No Light: The light source is not functioning properly.

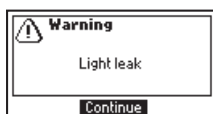

Light Leak: There is an excess amount of ambient light reaching the detector.



Inverted Cuvette: The sample and the zero cuvettes are inverted.



Light Low: The instrument cannot adjust the light level. Please check that the sample does not contain any debris.



Light High: There is too much light to perform a measurement. Please check the preparation of the zero cuvette.

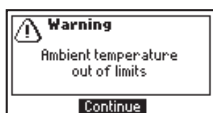

Ambient temperature out of limits: The meter is too hot or too cold for an accurate measurement. Allow the meter to reach 10 °C to 40 °C (50 °F to 104 °F) before performing a measurement.



Ambient temperature changed: The temperature of the meter has changed significantly since the zero measurement has been performed. A zero measurement must be performed again.

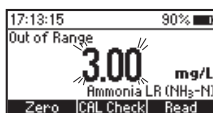

Out of range: The measured value is outside the limits of the method.

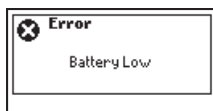

Battery Low: Battery is low, replace the batteries with new ones.

10. BATTERY REPLACEMENT

To replace the instrument's batteries, follow these steps:

- Turn the instrument off by pressing and holding the  key.
- Remove the battery cover by turning it counterclockwise.
- Remove the old batteries, replace them with three new 1.5V AA batteries.
- Replace the battery cover, turn it clockwise to close.

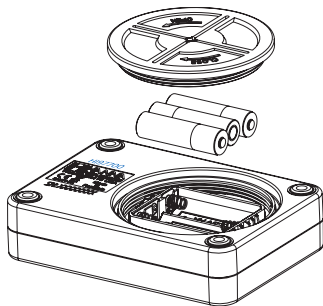

11. ACCESSORIES

11.1. REAGENT SETS

Code	Description
HI93700-01	Ammonia LR Reagent - 100 tests
HI93700-03	Ammonia LR Reagent - 300 tests

11.2. OTHER ACCESSORIES

Code	Description
HI7101412	blue carrying case for HI977XX and 2 CAL Check cuvettes
HI731318	cloth for wiping cuvettes (4 pcs.)
HI731331	glass cuvettes (4 pcs.)
HI731336N	cap for cuvette (4 pcs.)
HI97700-11	CAL Check® standards for ammonia LR - cuvette kit
HI93703-50	cuvette cleaning solution (230 mL)

Certification

All Hanna Instruments conform to the **CE European Directives**.



RoHS
compliant

Disposal of Electrical & Electronic Equipment. The product should not be treated as household waste. Instead hand it over to the appropriate collection point for the recycling of electrical and electronic equipment which will conserve natural resources.

Disposal of waste batteries. This product contains batteries, do not dispose of them with other household waste. Hand them over to the appropriate collection point for recycling.

Ensuring proper product and battery disposal prevents potential negative consequences for the environment and human health, which may be caused by inappropriate handling. For more information, contact your city, your local household waste disposal service, the place of purchase or go to www.hannainst.com.



Recommendations for users

Before using this product, make sure it is entirely suitable for your specific application and for the environment in which it is used. Any variation introduced by the user to the supplied equipment may degrade the meter's performance. For yours and the meter's safety do not use or store the meter in hazardous environments.

Warranty

The **HI97700** is warranted for two years against defects in workmanship and materials when used for its intended purpose and maintained according to instructions. This warranty is limited to repair or replacement free of charge. Damage due to accidents, misuse, tampering or lack of prescribed maintenance is not covered.

If service is required, contact your local Hanna Instruments Office. If under warranty, report the model number, date of purchase, serial number (engraved on the bottom of the meter) and the nature of the problem. If the repair is not covered by the warranty, you will be notified of the charges incurred. If the meter is to be returned to Hanna Instruments, first obtain a Returned Goods Authorization (RGA) number from the Technical Service department and then send it with shipping costs prepaid. When shipping any meter, make sure it is properly packed for complete protection.

Hanna Instruments reserves the right to modify the design, construction or appearance of its products without advance notice.

World Headquarters

Hanna Instruments Inc.
Highland Industrial Park
584 Park East Drive
Woonsocket, RI 02895 USA
www.hannainst.com

Local Office

Hanna Instruments Inc.
Highland Industrial Park
584 Park East Drive
Woonsocket, RI 02895 USA
Phone: 800.426.6287
Fax: 401.765.7575
e-mail: tech@hannainst.com