

# HI801

**iris**

## VISIBLE SPECTROPHOTOMETER



INSTRUCTION MANUAL

**Dear  
Customer,**

Thank you for choosing a Hanna Instruments product.

Please read this instruction manual carefully before using this instrument. This manual will provide you with the necessary information for the correct use of this instrument, as well as a precise idea of its versatility.

If you need additional technical information, do not hesitate to e-mail us at [tech@hannainst.com](mailto:tech@hannainst.com) or view our worldwide contact list for a Hanna Instruments representative near you at [www.hannainst.com](http://www.hannainst.com).

1. PRELIMINARY EXAMINATION .....	5
2. SAFETY MEASURES .....	5
3. SPECIFICATIONS .....	6
4. DESCRIPTION .....	7
4.1. GENERAL DESCRIPTION .....	7
4.2. FUNCTIONAL DESCRIPTION .....	7
4.3. PRINCIPLE OF OPERATION .....	10
4.4. OPTICAL SYSTEM .....	11
5. OPERATING MODE .....	12
5.1. START UP .....	12
5.2. POWER AND BATTERY MANAGEMENT .....	12
5.3. CUVETTE ADAPTERS.....	13
5.4. METHODS .....	15
5.5. TIMERS .....	15
5.6. DATA MANAGEMENT .....	16
6. SETUP .....	16
6.1. METER SETUP .....	17
6.1.1. FAVORITE METHODS .....	17
6.1.2. AUTOMATIC LOG.....	17
6.1.3. METER ID .....	17
6.1.4. SAMPLE ID .....	18
6.1.5. BEEPER .....	18
6.1.6. LCD CONTRAST .....	18
6.1.7. LETTER SCROLL .....	19
6.1.8. CSV FIELD SEPARATOR .....	19
6.1.9. DATE AND TIME SETTING.....	19
6.1.10. CUVETTE DETECTION .....	21
6.1.11. AUTO OFF .....	21
6.1.12. FACTORY RESET .....	21
6.1.13. RESET CONFIGURATION .....	21
6.2. SYSTEM CHECK .....	21
6.2.1. SYSTEM INFO .....	22
6.2.2. UPGRADE .....	22
6.2.3. LAMP CHECK .....	22
6.2.4. WAVELENGTH CHECK .....	22
6.2.5. LAMP HISTORY .....	23
6.3. USB .....	23
6.3.1. METHODS .....	23
6.3.2. REPORTS .....	24
6.3.3. CONNECT TO PC .....	27
6.4. METHOD SETTINGS (USER METHODS ONLY) .....	28
6.4.1. MEASUREMENT UNIT .....	28
6.4.2. NUMBER OF WAVELENGTHS .....	28
6.4.3. WAVELENGTH SETTING .....	28
6.4.4. DECIMALS .....	28

6.4.5. DILUTION FACTOR .....	29
6.4.6. VIAL TYPE .....	29
6.4.7. NUMBER OF TIMERS .....	29
6.4.8. TIMER SETTING .....	30
6.4.9. MULTI WAVELENGTH FORMULA .....	30
6.4.10. CALIBRATION .....	32
7. METHODS .....	37
7.1. FACTORY METHODS .....	37
7.2. USER METHODS .....	38
7.3. FAVORITE METHODS .....	39
7.4. CREATE NEW .....	39
7.4.1. METHOD NAME .....	39
8. WARNING AND ERROR MESSAGES.....	40
8.1. WARNING MESSAGES.....	40
8.2. ERRORS.....	41
9. ABBREVIATIONS .....	42
10. ACCESSORIES .....	43
11. SPARE PARTS .....	44
11.1. BATTERY REPLACEMENT .....	44
11.2. LAMP REPLACEMENT .....	44
RECOMMENDATIONS FOR USERS .....	46
WARRANTY .....	47
CERTIFICATION.....	47



## 1. PRELIMINARY EXAMINATION

Remove the instrument and accessories from the packaging and examine them carefully to make sure that no damage has occurred during shipping. Notify your nearest Hanna Customer Service Center if damage is observed.

Each HI801 iris spectrophotometer is supplied with:

- Sample Cuvette and Cap, 22 mm (4 pcs.)
- Cloth for Wiping Cuvettes
- Scissors
- USB Cable
- 15 VDC Power Adapter
- Instruction Manual
- Instrument Quality Certificate
- USB Flash Drive

*Note: Save all packing material until you are sure that the instrument works correctly. Any damaged or defective item must be returned in its original packaging with the accessories supplied.*

## 2. SAFETY MEASURES



- The chemicals contained in the reagent kits may be hazardous if improperly handled.
- Read the Safety Data Sheet (SDS) before performing tests.
- Safety equipment: Wear suitable eye protection and clothing when required, and follow instructions carefully.
- Reagent spills: If a reagent spill occurs, wipe up immediately and rinse with plenty of water. If reagent contacts skin, rinse the affected area thoroughly with water. Avoid breathing released vapors.
- Waste disposal: For proper disposal of reagent kits and reacted samples, contact a licensed waste disposal provider.

To prevent injury, death or damage to the instrument:

- Use only the power supply, battery and accessories specified in the manual.
- Do not open, disassemble or modify the battery pack or instrument.
- Do not expose the battery or instrument to excess heat.
- Before storing the instrument for an extended period of time, remove the battery pack and disconnect the power plug.
- Do not use or store the battery or instrument in dusty or humid places.
- Do not shake, drop or subject the instrument to physical shock.
- Do not leave the instrument near objects with strong magnetic fields.

To prevent fire or electrical shock:

- Ensure the power adapter is completely plugged in.
- Never handle the power adapter or battery with wet hands.
- Do not leave the battery or meter near a heat source.
- Do not insert any foreign objects in the power adapter connector or battery compartment.
- Do not recharge battery outside ambient temperature conditions (0 to 45 °C).

*Note: If the meter experiences a sudden temperature change allow it to equilibrate before turning on. Condensation may have formed on the instrument and on the internal parts.*

## 3. SPECIFICATIONS

Wavelength Range	340-900 nm
Wavelength Resolution	1 nm
Wavelength Accuracy	±1.5 nm
Photometric Range	0.000-3.000 Abs
Photometric Accuracy	5 mAbs at 0.000-0.500 Abs 1% at 0.500-3.000 Abs
Measurement Mode	transmittance (%) absorbance concentration
Sample Cell	10 mm square 50 mm rectangular 16 mm round 22 mm round 13 mm round (vial)
Wavelength Selection	automatic, based on the selected method (editable for user methods only)
Light Source	tungsten halogen lamp
Optical System	split beam
Wavelength Calibration	internal, automatic at power-on with visual feedback
Stray Light	<0.1 % T at 340 nm with NaNO <sub>2</sub>
Spectral Bandwidth	5 nm
Number of Methods	up to 150 factory (85 pre-loaded) up to 100 user
Data Points Stored	9999 measured values
Export Capability	csv file format pdf file format
Connectivity	1x USB A (mass storage host) 1x USB B (mass storage device)
Battery Life	3000 measurements or 8 hours
Power Supply	15 VDC power adapter 10.8 VDC Li-Ion rechargeable battery
Environment	0 to 50 °C (32 to 122 °F); 0 to 95% RH
Dimensions	155 x 205 x 322 mm (6.1 x 8.0 x 12.6")
Weight	3 kg (6.6 lbs.)

## 4. DESCRIPTION

### 4.1. GENERAL DESCRIPTION

The HI801 iris visible spectrophotometer is a compact and versatile instrument with a split beam optical system. It features a visible wavelength range from 340 to 900 nm. The meter features an internal reference system, that reduces errors caused by lamp intensity and temperature fluctuations. The optical system has been designed to minimize stray light, improving linearity and accuracy.

The spectrophotometer is supplied with 85 factory methods. These methods are pre-programmed with all of the information necessary to complete an analysis, including the wavelength, vial type, calibration curve and timers. Up to 100 user methods can be created. Users can select up to 5 wavelengths and timers, cuvette type, and enter their own calibration curves (concentration only). Calibration curves can contain up to 10 points, with a linear regression curve fit to the data. The slope, offset and R-squared ( $R^2$ ) are visible for the calibration curve. Both factory and user methods are easily accessible from the main screen using the favorite methods option.

- Supplied with 85 factory methods
- Create up to 100 user methods
- 5 cuvette types (16 mm round, 22 mm round, 13 mm vial, 10 mm square, 50 mm rectangular) with automatic detection
- Data storage for 9999 measurements with ability to auto log results
- Simplified data transfer to a PC or Mac
- Field upgradeable firmware
- Rechargeable battery

### 4.2. FUNCTIONAL DESCRIPTION

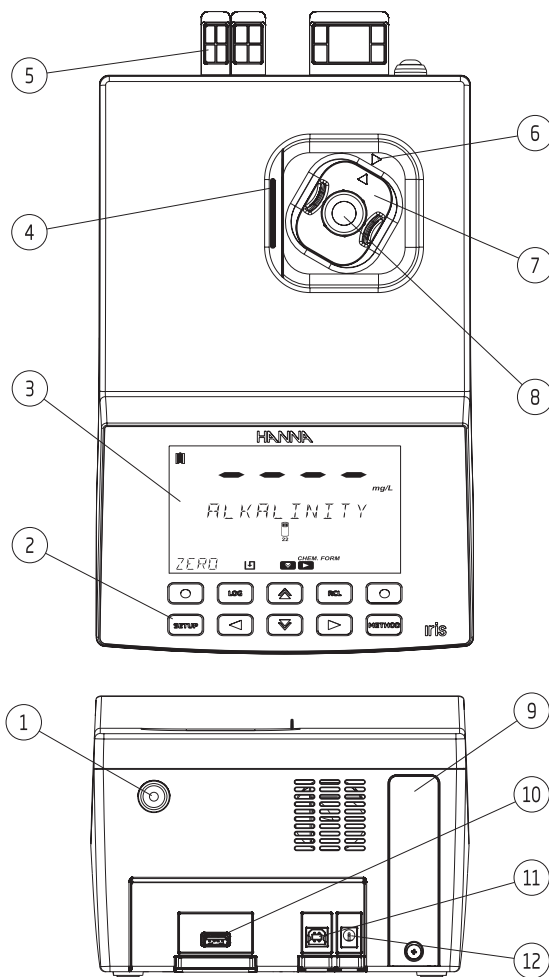









- 1) ON / OFF power button
- 2) Keypad
- 3) LCD
- 4) Lid
- 5) Protective port covers
- 6) Indexing mark
- 7) Cuvette adapter
- 8) Cuvette
- 9) Battery cover
- 10) USB connector for USB Flash Drive
- 11) USB connector for PC connection
- 12) Power adapter connector

## KEYPAD DESCRIPTION



The keypad contains 8 direct keys and 2 functional keys with the following functions:

-  Functional keys. Press to perform the function displayed above it on the **LCD**.
-  Press to access the **METHOD** menu.
-  Press to move up in a menu to increment a value or to access the **FAVORITE METHODS** from the **MAIN SCREEN**.
-  Press to go back to a previous level of the menu, scroll through letter places in the method creation process or to access the **TIMER MENU** on the **MAIN SCREEN**.
-  Press to move down in a menu or to decrement a set value.
-  Press to advance in the menu, to scroll through letter places in the method creation setup or to access the **CHEMICAL FORMULAS** for factory method on the **MAIN SCREEN**.
-  Press to access the **SETUP** menu.
-  Press to save the current measurement.
-  Press to recall logged measurements.

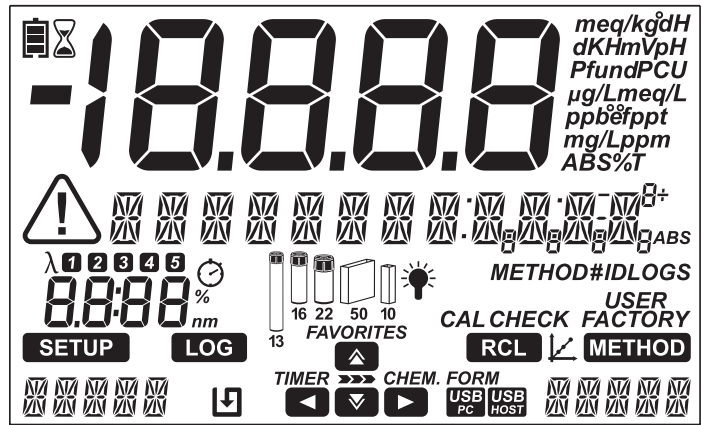

Tag	Description
	Battery Indicator and Charging Status
	Warning Indicator
	Timer Indicator
	Wavelength Indicator
	Tags used to indicate the selected wavelength or timer
	Vial type indicator for the selected method*
	Lamp Status
	Indicates the Active Menu
	Indicates Navigation Level in Menus
	Indicates Arrow Key is Active
	Calibration Indicator
	Auto Logging Enabled
	PC Connection Established
	Flash Drive Connection Established

\*Note: For factory methods the indicated vial must be used to obtain valid measurements.

### 4.3. PRINCIPLE OF OPERATION

Absorption of light is a typical phenomenon of interaction between electromagnetic radiation and matter.

A spectrophotometer separates electromagnetic radiation (white light) into its component wavelengths and selectively measures the intensity of the radiation after it passes through a sample.

The white light is passed through a prism to disperse the light into bands of color. These bands of color make up the visible light spectrum and correlate to the wavelength.

Wavelength (nm)	Absorbed Color	Transmitted Color
400	violet	yellow-green
435	blue	yellow
495	green	purple
560	yellow	blue
650	orange	greenish blue
800	red	bluish green

When a light beam crosses a substance, some of the radiation may be absorbed by atoms, molecules or crystal lattices.

If pure absorption occurs, the fraction of light absorbed depends both on the optical path length through the matter and on the physical-chemical characteristics of the substance according to the Beer-Lambert Law:

$$T = I/I_o$$

$$-\log I/I_o = \epsilon_{\lambda} c d$$

or

$$A = \epsilon_{\lambda} c d$$

- T = transmittance  
 A = absorbance  
 $I_o$  = intensity of incident light beam  
 I = intensity of light beam after absorption  
 $\epsilon_{\lambda}$  = molar extinction coefficient at wavelength  $\lambda$   
 c = molar concentration of the substance  
 d = optical path through the substance

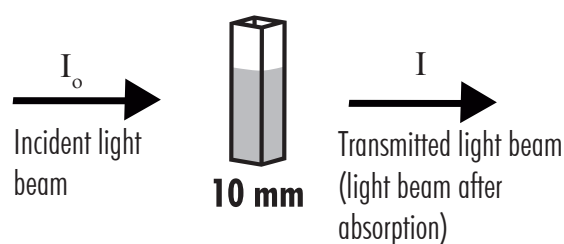

The concentration "c" can be calculated from the absorbance of the substance as the other factors are constant.

Photometric chemical analysis is based on specific chemical reactions between a sample and reagent to produce a light-absorbing compound.

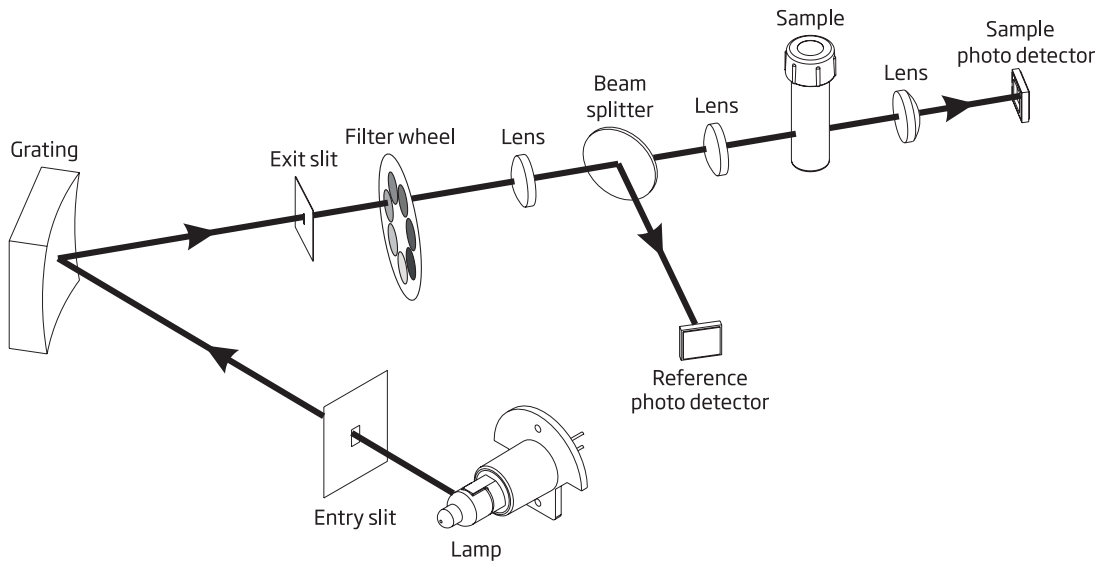

Optical System Block Diagram

A tungsten halogen **lamp** is used as the light source for the entire working range of the meter (340 nm to 900 nm). The tungsten halogen lamp produces a white light that is passed to a diffraction **grating**.

The diffraction **grating** splits the polychromatic white light into the visible color spectrum, allowing for specific wavelengths to be selected.

The light is then passed through an optical **filter** to reduce stray light and improve measurement accuracy.

The internal reference system uses a **reference photo detector** to compensate for drifts due to lamp intensity, ambient temperature and environmental changes, providing a stable source of light.

Focusing **lenses** are used throughout the optical system to ensure all of the light is being collected. This allows a brighter, stronger signal to be received.

After the light exits the cuvette a final focusing **lens** is used. This reduces error from cuvette imperfection and scratches eliminating the need to index the cuvette.

## 5. OPERATING MODE

### 5.1. START UP

When the instrument is powered on, all the LCD tags will be visible for several seconds before the auto-diagnostic tests run. This process will take several seconds, during this time the progress will be displayed on the screen. Once these tests are completed the main screen will be displayed.

These tests ensure that the meter is working properly. If any errors occur a warning message will be displayed.

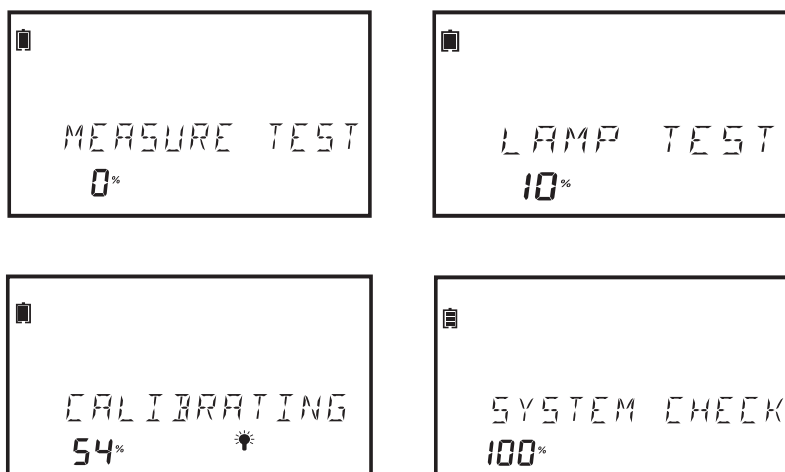

If there are no methods installed, "No Method Loaded" message is displayed.

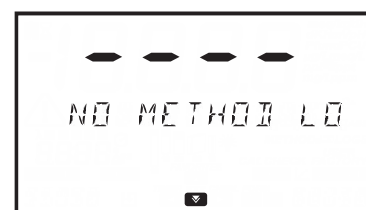

### 5.2. POWER AND BATTERY MANAGEMENT

The meter can be powered from an **AC/DC** power adapter or from the rechargeable battery.

To conserve power, the auto off option can be enabled in the setup menu, see page 21 for more information. If this option is enabled, the instrument will automatically turn off after a defined period of time if no interaction has occurred.

The battery icon on the display will indicate the battery and charging status:

Battery is charging from external adapter

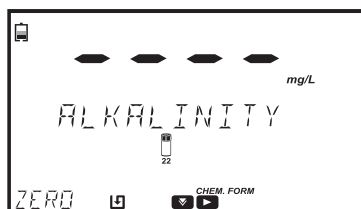



Battery fully charged (connected to power adapter)

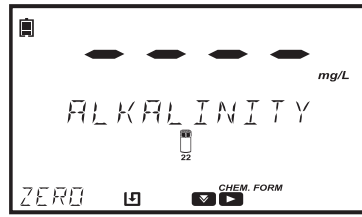

Battery near 0% (no external power adapter)

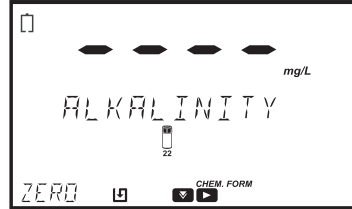

### 5.3. CUVETTE ADAPTERS

The HI801 iris spectrophotometer is designed to work with five different cuvettes:

- 22 mm round
- 16 mm round
- 13 mm vial
- 10 mm square
- 50 mm rectangular

The meter is supplied with three cuvette adapters:

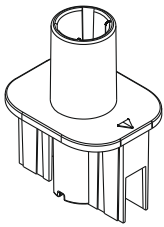

adapter for 13 mm vial

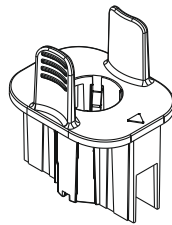

adapter for 16 mm cuvette

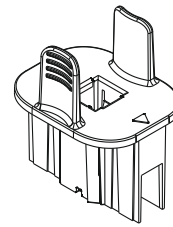
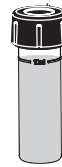

adapter for 10 mm square cuvette

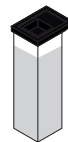

*Note: The 22 mm round and 50 mm rectangular cuvettes do not require adapters. The cuvettes can be directly inserted into the meter.*

To prepare the meter for the use of adapters:

1. Open the meter's lid.
2. Select the adapter according to the cuvette type required for the selected method.
3. Orient the adapter so that indexing mark is aligned with the indexing mark located inside the meter.
4. Using light pressure, push the adapter down until it reaches the bottom of the meter's holder.

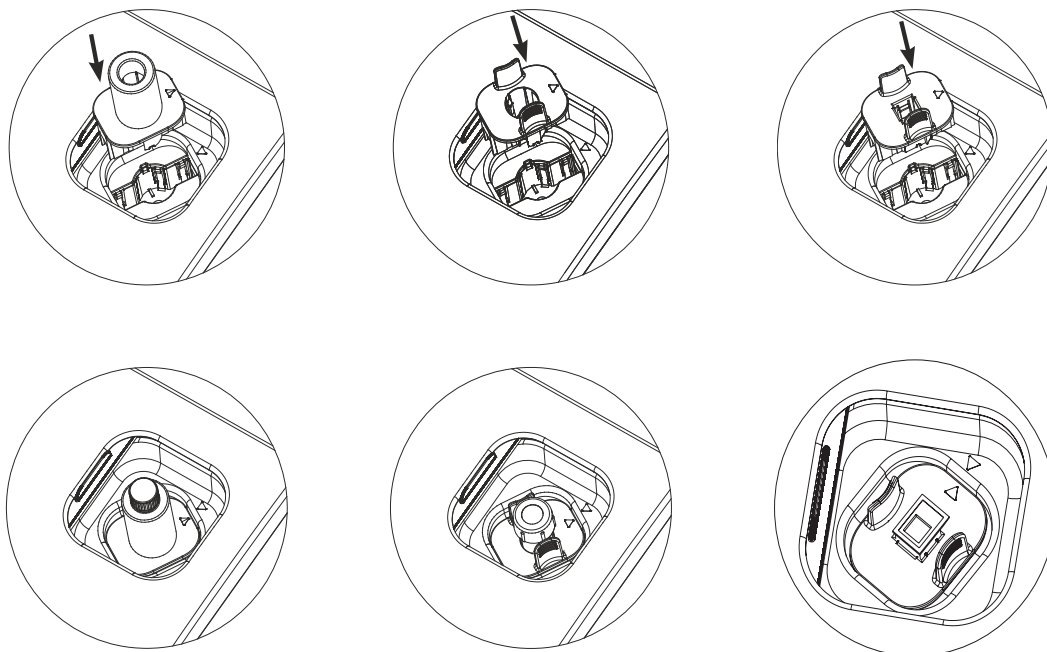

5. The meter is ready for use. Always utilize the selected adapter for both "Zero" and "Read" measurements as specified in the method instructions.

**WARNING:** Improper use of the vial adapters could cause irreversible damage to the meter. Always use the following precautions when using vial adapters.

- Never use excessive force to insert the adapter. You should be able to insert the vial with light pressure. If the vial is not reaching the bottom, if there is large resistance, or if you are receiving a "light low" error during the "Zero" operation, re-check that the indexing marks are aligned on the adapter and meter.
- Never insert hot vials/samples into the vial adapter. Samples should be near room temperature before inserting into the meter/adapter.
- Do not attempt to close the sample cover while using the 13 mm vials or adapter. It is normal for the vials/adapter to prevent the cover from closing completely.

## 5.4. METHODS

The HI801 iris spectrophotometer can run two different types of methods; factory methods and user methods.

Factory methods were developed by Hanna Instruments. These methods are pre-programmed with all of the information needed to run an analysis. These methods are calibrated for the selected wavelength, vial type and reagent set, see page 37 for more information.

User methods are developed by the user. These methods can be customized based on the analysis. Options include multiple wavelengths, vial type, reaction timers, calibration curves, etc. For additional information for creating new user methods, see page 39. For additional information about modifying a user method, see page 28.

Factory and User Methods can be tagged as Favorite Methods, if enabled, see page 17 for more information. Favorite Methods are easily accessible from the main screen by pressing the  key.

## 5.5. TIMERS

Each method requires a different measurement procedure.

If a timer or timers is used during the measurement procedure the  key will be visible on the main screen with the **TIMER** tag above it.

Press the  key to access the timer menu. Press the **START** key to start Timer 1, the display will show the countdown. To stop and reset the timer, press the **STOP** key.

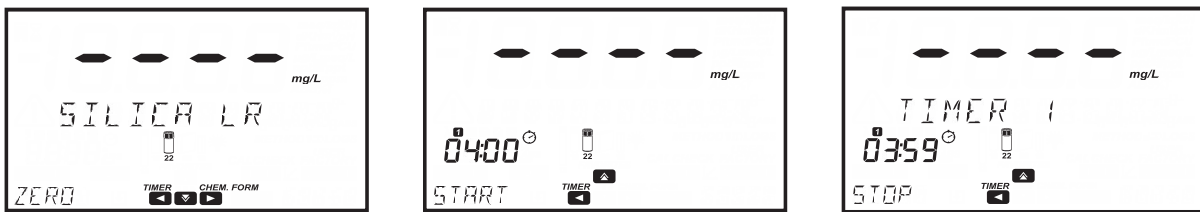

If the method requires more than one timer. Press the  key to access the timer menu and press the  key to select Timer 2 to Timer 5.

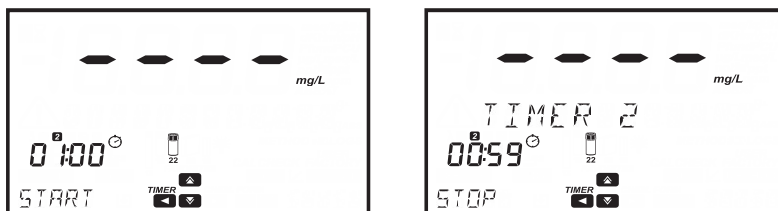

When the timer has expired press the **ZERO** or **READ** key to continue. If the timer beeper is enabled a long beep will be heard when the timer reached "00:00", see page 18 for more information.

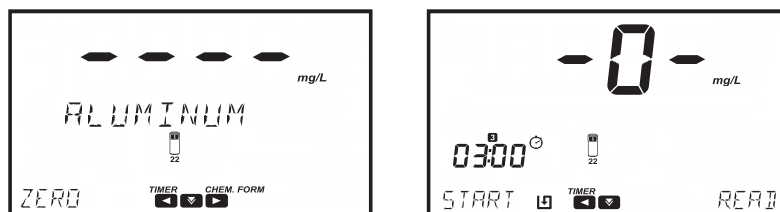

*Note: A zero measurement must be done before a read measurement. Follow the instructions in the method procedure for preparation of the zero cuvette.*

### 5.6. DATA MANAGEMENT

The meter can hold up to 9999 measurements. Data can be reviewed on the screen or transferred to a PC.



#### LOG DATA

Data can be saved in two different ways:

If Automatic Log is enabled the meter automatically saves the reading. The  is shown on the display when this feature is enabled, see page 17 for more information.

Measurements can also be saved by pressing the  key.

If Sample ID is enabled (see page 18 for additional information), the user will be prompted to enter a unique 2 digit ID for the saved measurement. The previously entered ID will be displayed automatically.

Press the **EDIT** key to modify the value. Use the  or  key to highlight the digit to be modified.

Press the  or  key to set the desired value.

Press the **CFM** key to confirm the Sample ID or the **CLR** key to return to the previous screen.

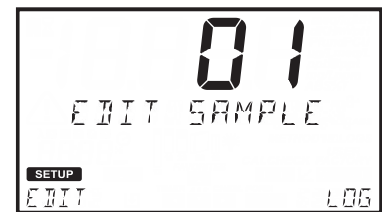
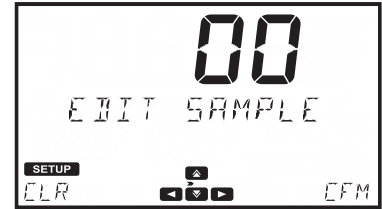

#### LOG RECALL

Data saved on the instrument can be viewed by pressing the  key.

Logs are displayed in order by date and time, the newest log is shown first. Press the  key to scroll through the available logs. Press the **INFO** key to view additional information for the selected log. The following information is saved for each measurement: method name, chemical formula (factory methods only), date and time of the measurement, sample ID, method ID, wavelength and absorbance (user methods only).

Individual logs can be deleted by pressing the **CLR** key, which prompts a confirmation screen: "Are you sure you want to delete this log".

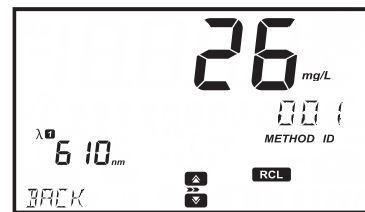

#### DATA TRANSFER

All data stored on the meter can be saved to a PC/Mac or exported to a USB flash drive, see page 23 for more information.

### 6. SETUP

Press the  key to enter the setup menu, use the  or  key to select the submenu.

The available options are **METHOD SETTINGS** (if user method is selected, see page 28), **METER SETUP**, **SYSTEM CHECK** and **USB**.

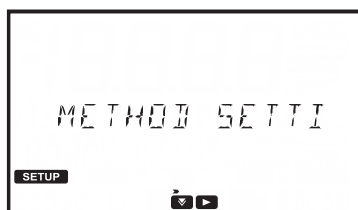

To view the options in the selected submenu press the  key

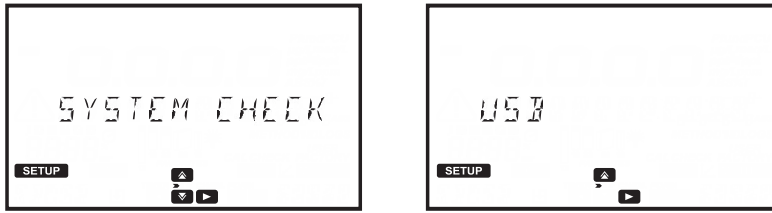

To return to the main screen press the  key.

## 6.1. METER SETUP

Use the  or  key to select **METER SETUP**, press the  key to enter the menu.

**METER SETUP** allows you to modify the meter's general functionality, these settings do not affect the measurement.

### 6.1.1. FAVORITE METHODS

**Option: ON or OFF**

When this option is **ON** methods can be marked as favorites. Favorite methods are easily accessible on the main screen by pressing the  key, see page 38 for more information. Up to 30 methods can be marked as favorites.



### 6.1.2. AUTOMATIC LOG

**Option: ON or OFF**

When this option is **ON**, measurements are automatically saved in the log. When this option is **OFF**, measurements can be added to the log by pressing the  key. When enabled the  tag is displayed on the main screen.

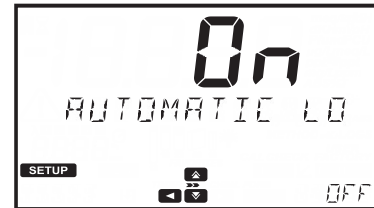





### 6.1.3. METER ID

**Option: 0000 to 9999**

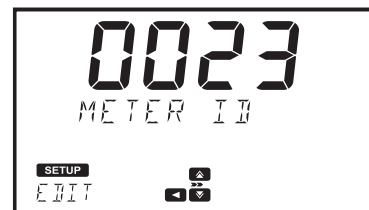
This option is used to set the instrument's identification number.

Press the **EDIT** key to set a meter ID.



Use the  or  key to highlight the digit to be modified. Press the  or  key to set the desired value. Press the **CFM** key to confirm the meter ID or the **CLR** key to return to the setup menu without saving.

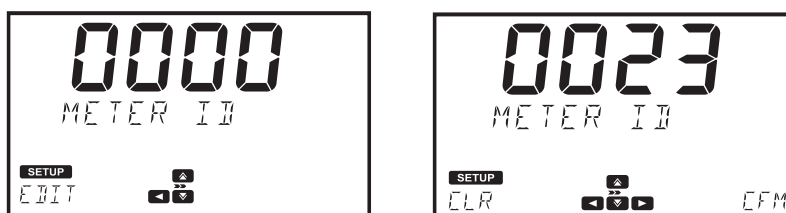

### 6.1.4. SAMPLE ID

**Option: ON or OFF**

If this option is ON the user will be prompted to enter a sample ID when a measurement is saved.

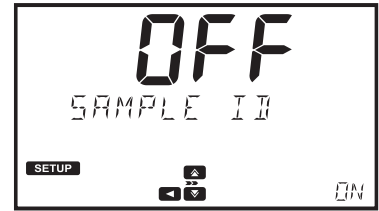

### 6.1.5. BEEPER

Use the  key to access the beeper submenu.

The available options are: **KEY PRESS**, **ERRORS** and **TIMERS**.



#### KEY PRESS

**Option: ON or OFF**

If this option is ON, a short beep is heard every time an active key is touched, a long beep is heard every time an inactive key is touched.



#### ERRORS

**Option: ON or OFF**

If this option is ON, a long beep is heard every time an error occurs.



#### TIMERS

**Option: ON or OFF**

If this option is ON, a long beep will be heard when a timer reaches "00:00".

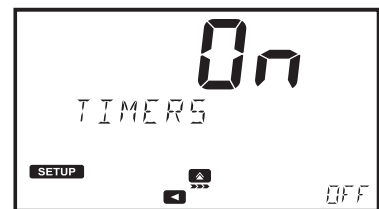

### 6.1.6. LCD CONTRAST

**Option: 0 to 7**

Press **EDIT** key to change the displays contrast.

Use the  or  key to increase or decrease the value.

Press the **CFM** key to save the value or the **CLR** key to return to the setup menu without saving.

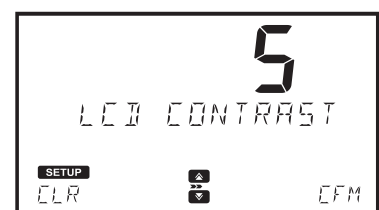
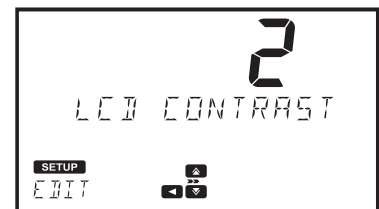

### 6.1.7. LETTER SCROLL

**Option: LETTER SCROLL or WORD SCROLL**

Press the **EDIT** key to change the scrolling text. Use the  or  key to select the desired type.

Press the **CFM** key to save the type or the **CLR** key to return to the setup menu without saving.



### 6.1.8. CSV FIELD SEPARATOR

**Option: Comma (,) or Semicolon (;)**

Press the  key to access the submenu.

Press **EDIT** key to change the type.

Use the  or  key to select the field separator.

Press the **CFM** key to confirm the field separator or the **CLR** key to return to the setup menu without saving.



### 6.1.9. DATE AND TIME SETTING

Use the  key to access the date and time submenu.

The available options are: **TIME FORMAT, DATE FORMAT, SET DATE and SET TIME.**



#### TIME FORMAT

**Option: 24 H or 12 H**

Press the **EDIT** key to change the time format.

Use the  or  key to select the desired time format.

Press the **CFM** key to confirm the time format or the **CLR** key to return to the previous screen without saving.

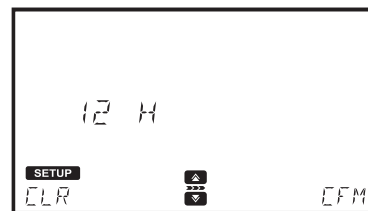

### DATE FORMAT

Option: DD/MM/YYYY, MM/DD/YYYY or YYYY/MM/DD

Press the **EDIT** key to change the date format.



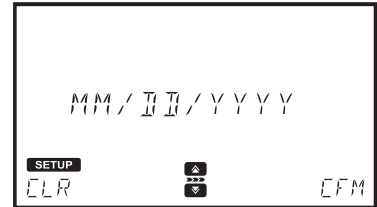
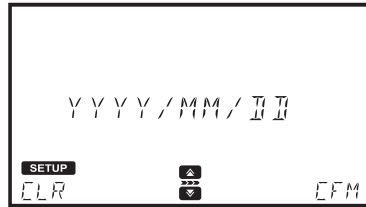
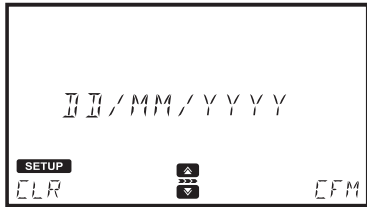

Press the  or  key to select the desired date format.

Press the **CFM** key to confirm the date or the **CLR** key to return to the previous screen without saving.



### SET DATE

Press the **EDIT** key to modify the date.

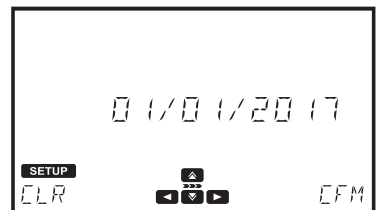

Use the  or  key to highlight the digit to be modified. Press the  or  key to set the desired value.

Press the **CFM** key to save the date or the **CLR** key to return to the previous screen without saving.



### SET TIME

Press the **EDIT** key to modify the time.

Use the  or  key to highlight the digit to be modified. Press the  or  key to set the desired value.

Press the **CFM** key to save the time or the **CLR** key to return to the previous screen without saving.

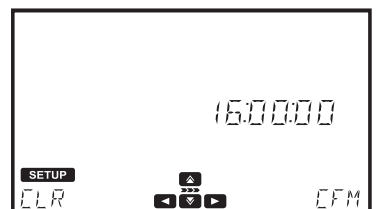
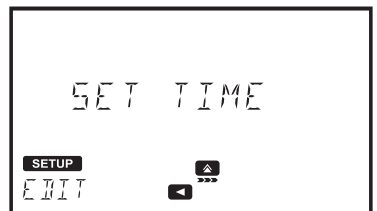



### 6.1.10. CUVETTE DETECTION

**Option: On or OFF**

If this option is **ON**, automatic cuvette detection is enabled. If the wrong cuvette is used an error message will be displayed.

If this option is **OFF**, the indicated cuvette must be used with the factory methods to get a valid measurement.



### 6.1.11. AUTO OFF

**Option: OFF, 5, 10, 30 or 60 minutes**

This option helps conserve power when the instrument is not being used. If there is no interaction between the user and the instrument for the set amount of time, the instrument will automatically turn off to preserve the battery.

If the auto off is set to **OFF** and the power adapter is removed, the meter will auto off after 60 minutes unless the power adapter is reconnected.

Press the **EDIT** key to modify value.

Use the  or  key to select the desired value.

Press the **CFM** key to confirm the auto off or the **CLR** key to return to the setup menu without saving.

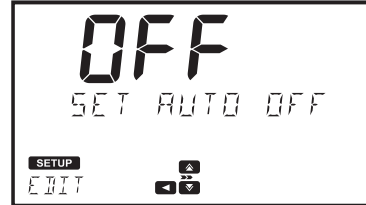

### 6.1.12. FACTORY RESET

This option will reset the instrument to its factory settings.

Press the **CFM** key to perform the factory reset.

Press the **YES** key to continue or the **NO** key to return to the meter setup menu.

*Note: Back up all data before you continue to prevent accidental data loss. Once this process has been started, it cannot be interrupted or reversed.*

The meter will restart when the factory restart is complete.



### 6.1.13. RESET CONFIGURATION

This option will reset all modifications made in the meter setup. All values will be reset to default.

Press the **CFM** key to reset the configuration. Press the **YES** key to continue or the **NO** key to return to the meter setup menu.



## 6.2. SYSTEM CHECK

Use the  or  key to select system check, press the  to enter the menu.

System check allows you to view information about the instrument and perform self diagnostic tests.



### 6.2.1. SYSTEM INFO

This option displays the instrument's serial number, firmware version and baseboard version.

Use the  key to access the system info menu.

Use the  or  key to scroll the displayed information.

Use the  key to return to the system check menu.

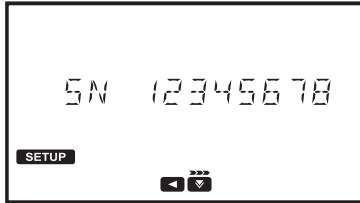
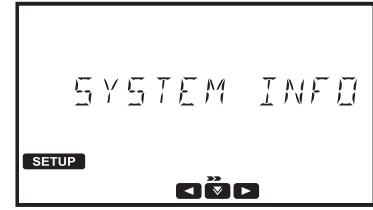

### 6.2.2. UPGRADE

This option upgrades the firmware.

Press the **CFM** key to update the firmware.

Insert a USB flash drive containing the update file into the port on the rear of the meter.

All data will be lost when the firmware is updated. Press the  key to return to menu or the  key to continue.

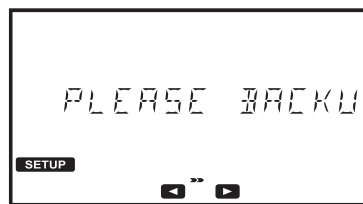

### 6.2.3. LAMP CHECK

This option performs a diagnostic check on the lamp.

If the lamp passes, the **PASS** message is displayed on the lower left side of the display.

To start a new test press the **CFM** key.

Use the  key to return to the system check menu.

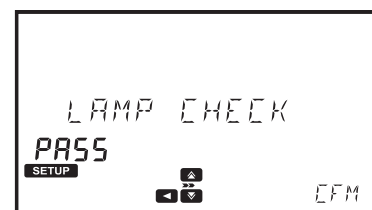

### 6.2.4. WAVELENGTH CHECK

This option allows users to check the wavelength positioning using a Holmium Oxide Glass Filter.

Press the **CFM** key to start the analysis.

Insert the zero cuvette and press the **ZERO** key.

Insert the holmium oxide filter and press the **READ** key.

Once the measurement is complete use the  and  keys to view the results. The wavelengths corresponding to the found peaks will be displayed on the lower left side of the screen.

Press the **EXIT** key to return to the menu.



### 6.2.5. LAMP HISTORY

Press the  key to view the number of hours the lamp has been running.

Press the **RESET** key to restart the counter. This should be performed after replacing the lamp.

Use the  key to return to the system check menu.

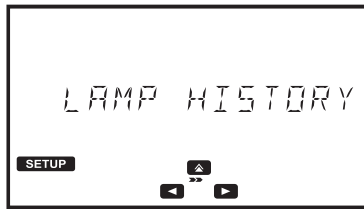

### 6.3. USB

Use the  or  key to select USB, press the  key to enter the menu.

Use this menu to import factory methods, import or export user methods, and export logs.

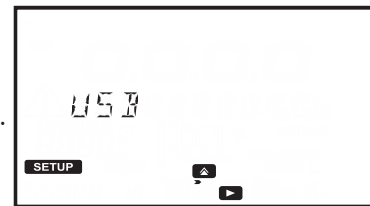

#### 6.3.1. METHODS

**Option: Factory Methods or User Methods.**

Use the  key to access the methods submenu.

Use the  or  key to scroll through the options.



#### FACTORY METHODS

**Option: Import All**

This option allows users to import factory methods from a USB flash drive.

Press the  key, Import All will be displayed, insert a USB flash drive containing the factory methods and press the **CFM** key. The process will start automatically, the display will show the progress. To avoid data corruption, do not remove the USB flash drive until the file transfer is complete.



Press the  key to return to the Factory Methods submenu.



USER METHODS

Option: Import All or Export All

This option allows users to import or export all user methods to/from a USB flash drive.

Press the  key. Import All will be displayed. Use the  or  key to select the desired option. Insert a USB flash drive and press the CFM key. The process will start automatically, the display will show the progress. To avoid data corruption, do not remove the USB flash drive until the file transfer is complete.

Exported methods can be transferred to other meters.

Press the  key to return to the METHODS menu.

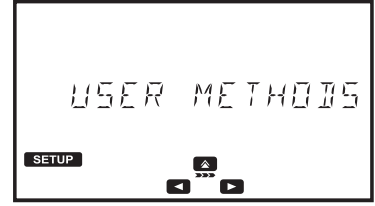

6.3.2. REPORTS

Options: By Sample ID (if enabled), By Method ID, or By Date.

Use the  key to access the reports submenu.



**BY SAMPLE ID (if enabled)**



This option allows users to generate and export reports by sample ID.

Press the  key. The select Sample ID screen is shown.

Press the **EDIT** key to edit the sample ID. Use the  or  key to highlight the digit to be modified. Press the  or  key to set the desired value.

Press the **CFM** key to confirm the Sample ID or the **CLR** key to return to the previous screen without saving.

Press the  key to select the file type. The selected file type will be displayed on the screen.

Press the **EDIT** key to change the file type. Use the  or  to select the file type. Press the **CFM** key to confirm the file type or the **CLR** key to return to the previous screen without saving.

Press the  key to continue. The "Create" message will be displayed. Press the **CFM** key to export the file. To avoid data corruption, do not remove the USB flash drive until the file transfer is complete.

*Note: If no USB Flash Drive is connected you will be prompted to connect the flash drive.*

**BY METHOD ID**

This option allows users to generate and export reports by method ID.



Press the  key. The select Method ID screen is shown.

Press the **EDIT** key to edit the method ID. Use the  or  key to highlight the digit to be modified. Press the  or  key to set the desired value.

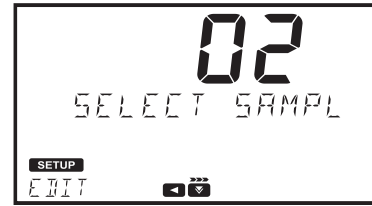
Press the **CFM** key to confirm the Method ID or the **CLR** key to return to the previous screen without saving.



Press the  key to select the file type. The selected file type will be displayed on the screen.

Press the **EDIT** key to change the file type. Use the  or  to select the file type. Press the **CFM** key to confirm the file type or the **CLR** key to return to the previous screen without saving.



Press the  key to continue. The "Create" message will be displayed.

Press the **CFM** key to export the file. To avoid data corruption, do not remove the USB flash drive until the file transfer is complete.

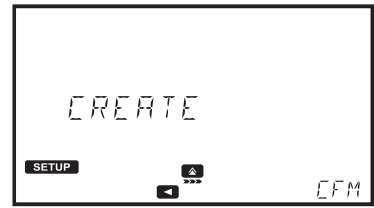

*Note: If no USB Flash Drive is connected you will be prompted to connect the flash drive.*



## BY DATE

This option allows users to generate and export reports by date.





Press the  key. The Start Date screen is shown.

Press the **EDIT** key to edit the start date. Use the  or  key to highlight the digit to be modified. Press the  or  key to set the desired value.

Press the **CFM** key to confirm the start date value or the **CLR** key to return to the previous screen without saving.



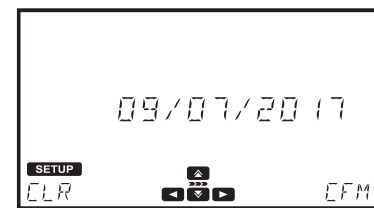

Press the  key to select the end date.

Press the **EDIT** key to edit the end date. Use the  or  key to highlight the digit to be modified. Press the  or  key to set the desired value. Press the **CFM** key to confirm the value end date or the **CLR** key to return to the previous screen without saving.



Press the  key to select the file type. The selected file type will be displayed on the screen.

Press the **EDIT** key to change the file type. Use the  or  to select the file type. Press the **CFM** key to confirm the file type or the **CLR** key to return to the previous screen without saving.



Press the  key to continue. The "Create" message will be displayed. Press the **CFM** key to export the file. To avoid data corruption, do not remove the USB flash drive until the file transfer is complete.

*Note: If no USB Flash Drive is connected you will be prompted to connect the flash drive.*

### 6.3.3. CONNECT TO PC

This option allows the instrument to be connected to a PC. Once the instrument is connected reports and user methods can be imported or exported directly from the unit.

Press the **CFM** key to enable the connection. The  tag and the message "Connected to PC" will be displayed. Use a file manager (such as Windows Explorer or Mac Finder) to move the files to/from the meter/PC. The meter will appear as a removable disk. To avoid data corruption, do not remove the USB cable until the file transfer is complete.

Press the **STOP** key to disconnect the instrument.



## 6.4. METHOD SETTINGS (USER METHODS ONLY)

Method Settings allows you to modify the settings and calibration curve for to the selected user method. These settings affect the measurement.

### 6.4.1. MEASUREMENT UNIT

**Option:** None, %T, ABS, ppm, mg/L, ppt, °f, °e, ppb, meq/L, µg/L, PCU, Pfund, pH, mV, dKH, °dH or meq/kg

This option allows you to select the measurement unit.

Press the **EDIT** key to select the measurement unit.

Use the  or  key to select the unit.

Press the **CFM** key to confirm the unit or the **CLR** key to return to the method settings menu without saving.



### 6.4.2. NUMBER OF WAVELENGTHS

**Option:** 1 to 5

The option allows you to select the number of wavelengths used in the method (Except for ABS or %T methods).

Press the **EDIT** key to change the number of wavelengths.

Use the  or  key to select the number of wavelengths.

Press the **CFM** key to confirm the number of wavelengths or the **CLR** key to return to the method settings menu without saving.



### 6.4.3. WAVELENGTH SETTING

**Options:** 340 to 900 nm

This options allows you to set the wavelength.

Press the **EDIT** key to modify the wavelength.

Use the  or  key to highlight the digit to be modified. Press the  or  key to set the desired value.

Press the **CFM** key to confirm the set wavelength or the **CLR** key to return to the method settings menu without saving.

*Note: Use the  key to view additional wavelengths (if enabled).*



### 6.4.4. DECIMALS

**Option:** 0 to 3

This option allows the user to set the measurement resolution (xxxx, xxx.x, xx.xx or x.xxx). Resolution for absorbance (ABS) and transmittance (%T) are fixed and cannot be modified.

Press the **EDIT** key to select the number of decimals.

Use the  or  key to select the number of decimals.

Press the **CFM** key to confirm the number of decimals or the **CLR** key to return to the method settings menu without saving.

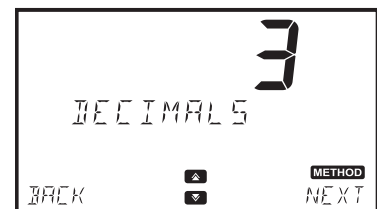



### 6.4.5. DILUTION FACTOR

**Option: 001 to 100**

This option allows the user to set the dilution factor used in sample preparation. This allows samples with high concentrations that are outside the measurement range to be measured. If the sample is not diluted enter a factor of 001.

Press the **EDIT** key to modify the dilution factor.

Use the  or  key to highlight the digit to be modified. Press the

 or  key to set the desired value.

Press the **CFM** key to confirm the dilution factor or the **CLR** key to return to the method settings menu without saving.

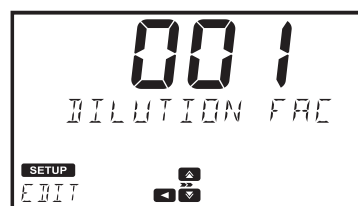

### 6.4.6. VIAL TYPE

**Option: 10mm, 13mm, 16mm, 22mm or 50 mm**

This option allows the user to select the vial used for measurement.

Press the **EDIT** key to select the vial type.

Use the  or  key to select the vial.

Press the **CFM** key to confirm the vial type or the **CLR** key to return to the method settings menu without saving.

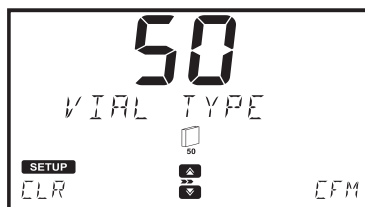
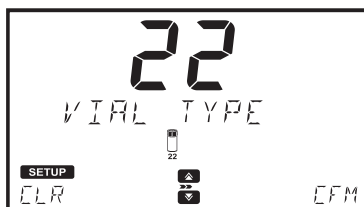
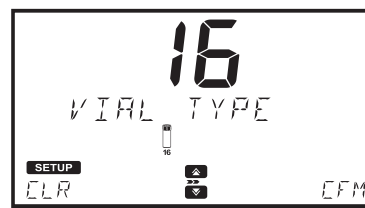
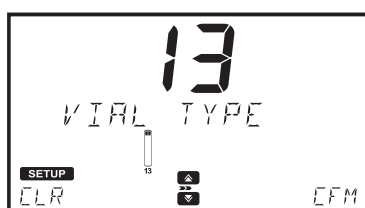
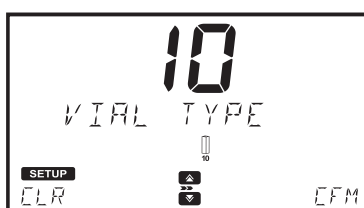

### 6.4.7. NUMBER OF TIMERS

**Option: 0 to 5**

The option allows you to select the number of timers used in the method.

Press the **EDIT** key to select the number of timers.

Use the  or  key to select the number of timers.

Press the **CFM** key to confirm the number of timers or the **CLR** key to return to the method settings menu without saving.



### 6.4.8. TIMER SETTING

Option: 00:00 to 59:59

This options allows you to select the timer length.

Press the **EDIT** key to modify the time.

Use the or key to highlight the digit to be modified. Press the or key to set the desired value.

Press the **CFM** key to confirm the time or the **CLR** key to return to the method settings menu without saving.

Press the **ENTER** key to modify the timer name.

Press the **EDIT** key to modify the name.

Use the or key to highlight the character to be modified. Press the or key to set the desired character.

Press the **CFM** key to confirm the timer name or the **CLR** key to return to the method settings menu without saving.

Press the **EXIT** key to return to the timer screen.

*Note: Use the key to view additional timers (if enabled).*



### 6.4.9. MULTI WAVELENGTH FORMULA

This option is only available if the selected method uses more than 1 wavelength. The final result can be calculated using equations with editable coefficients.

#### EQUATIONS:

The following equations can be used to calculate the final result.

Formula Sum:  $C = P_1 A_1 + P_2 A_2 + P_3 A_3 + P_4 A_4 + P_5 A_5$

Formula Fraction:  $C = \frac{P_1 A_1 + P_2 A_2 + P_3 A_3 + P_4 A_4 + P_5 A_5}{Q_1 A_1 + Q_2 A_2 + Q_3 A_3 + Q_4 A_4 + Q_5 A_5 + Q_6}$

Formula A1:  $C = P_1 A_1$

Formula A2:  $C = P_2 A_2$       C = Concentration

Formula A3:  $C = P_3 A_3$       A<sub>1</sub> to A<sub>5</sub> = Absorbance at specified wavelength

Formula A4:  $C = P_4 A_4$       P<sub>1</sub> to P<sub>5</sub> and Q<sub>1</sub> to Q<sub>6</sub> = Factors

Formula A5:  $C = P_5 A_5$

Press the **EDIT** key to select the equation.

Use the or to select the equation.

Press the **CFM** key to save the selection or the **CLR** key to return to the method settings.



*Note: The multiwavelength formula is not available for ABS and %T unit selected.*

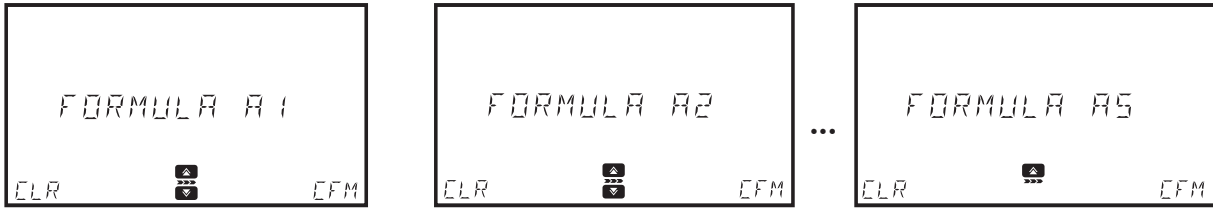

**FACTORS**

The meter will only display and use the factor needed for the selected equation.

Use the or to select the factor.

Press the **EDIT** key to modify the value.

Use the or key to highlight the digit to be modified. Press the or keys to set the desired value.

To shift the number (along with the decimal point) to the right use the key to highlight the digit furthest to the left and press the key, 9.876 will become 09.87, then 009.8, and 0009.



To make the number negative use the key to highlight the digit furthest to the left and press key to decrement the value.

To shift the number (along with the decimal point) to the left use the key to highlight the digit furthest to the right and press the key, -0009 will become -009.8, then -09.87, and -9.876, this can be done as long as you have leading zeros available.



The digit furthest to the left takes values from -9 to 9 by pressing the or keys, while the other digits are cyclic and take values from 0 to 9.

### 6.4.10. CALIBRATION

#### Option: Measure Standards or Manual ABS Entry

This option allows users to calibrate user methods by measuring the absorbance of known standards or manually entering absorbance values. Calibrations can contain up to 10 points.

*Note: This option is only available if a concentration unit is selected (i.e. mg/L, meq/kg, etc.). A calibration cannot be entered for methods using absorbance or % transmittance or multiwavelength methods. This option is only available for user methods. Factory methods have pre-programmed calibration curves based on the wavelength, cuvette type and reagent set.*



A calibration is required to run a new user method.

Press the  key to enter the menu. Use the  or  to select the desired option.

Press the  key to return to the calibration menu.

Once a method has been calibrated the  will be displayed on the main screen when the method is selected. If a user method has not been calibrated the error message "Not Calibrated" will be displayed.

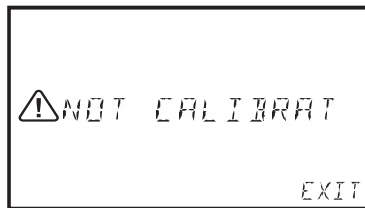

### MEASURE STANDARDS

This allows users to measure the absorbance of standards with a known concentration. Up to 10 points can be used to calibrate the method.



Press the **CFM** key to start the calibration.

Press the **EDIT** key to modify the concentration for the first standard.

Use the  or  key to highlight the digit to be modified. Press the  or  keys to set the desired value.

Press **CFM** to confirm the value or **CLR** to delete set value.

Press the  or **SETUP** key to abort the calibration.

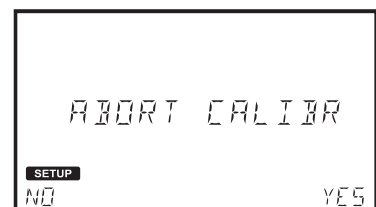

Press **NO** to return to the last calibration point screen or press **YES** to exit calibration.

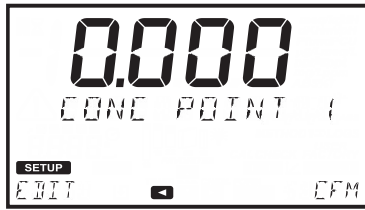

Press the **CFM** key to continue.

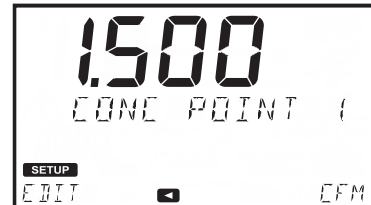
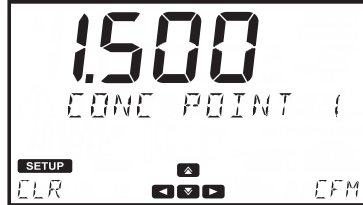
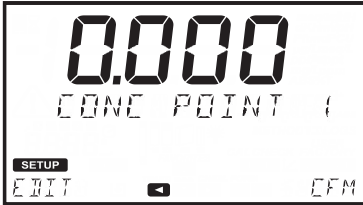

Insert the zero cuvette and press the **ZERO** key.

Insert the first standard and press the **READ** key.

Press the **CFM** key to save the value and continue or the **REDO** key to repeat the measurement.

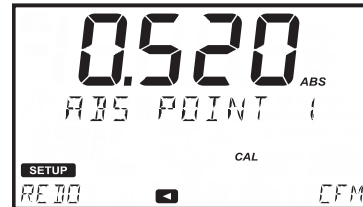
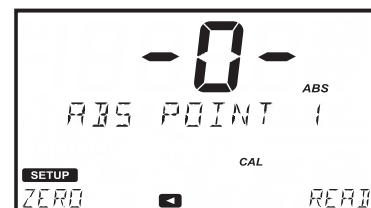
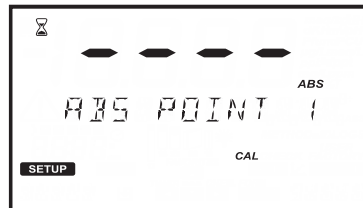
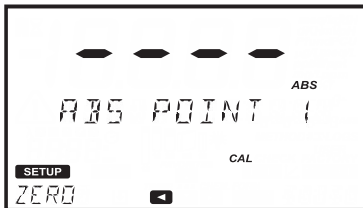

Press the **◀** key or **SETUP** to abort the calibration.

Press the **DONE** key to save and exit the calibration or the **MORE** key to add additional points.

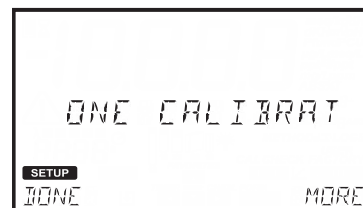

When wrong slope or offset occurred the meter will display an error message:

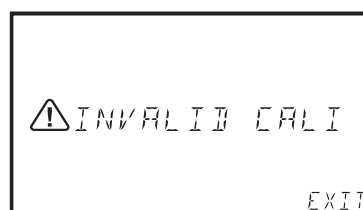

This procedure can be repeated until 10 calibration points have been added.

Edit concentration point		Measure Abs point	
.			.
	.		.
	.		.

**MANUAL ABS ENTRY**

This allows users to enter the absorbance of standards with a known concentration. Up to 10 points can be used to calibrate the method.



Press the **CFM** key to start the calibration.

Press the **EDIT** key to modify the concentration for the first standard.

Use the **◀** or **▶** key to highlight the digit to be modified. Press the **▲** or **▼** keys to set the desired value. Press **CFM** to confirm the value or **CLR** to delete set value. Press the **◀** or **SETUP** key to abort calibration.

Press the **CFM** key to continue.

--	--	--

Press the **EDIT** key to modify the absorbance for the first standard.

Use the **◀** or **▶** key to highlight the digit to be modified. Press the **▲** or **▼** keys to set the desired value. Press **CFM** to confirm the value or **CLR** to return to the method settings menu without saving. To set a negative abs value highlight the first digit and use **▲** or **▼** to select designed value.

Press the **CFM** key to save the value.

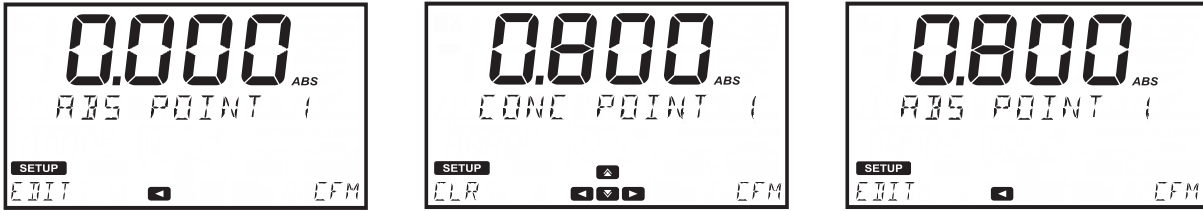

Press the **DONE** key to save and exit the calibration or the **MORE** key to add additional points. This procedure can be repeated until 10 calibration points have been added.



Edit concentration point

Edit Abs point

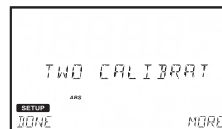
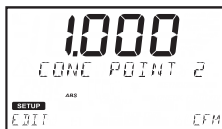
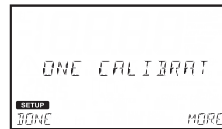

•  
•  
•

•  
•  
•

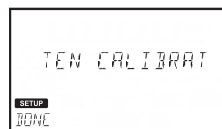

### VIEW CALIBRATION

After a calibration has been completed the calibration data can be viewed using **View Calibration**. A linear regression is done by the instrument for the saved calibration points, the meter will apply the best straight-line fit to the calibration points. The available options are: **SLOPE**, **OFFSET**, **R-SQUARED**, and **CALIBRATION POINTS**. Press the **CFM** key to view the calibration information.

Use the  or  to scroll through the options.

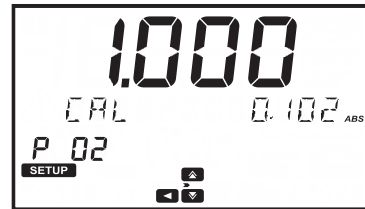
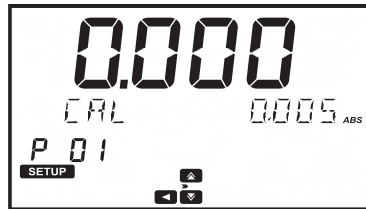
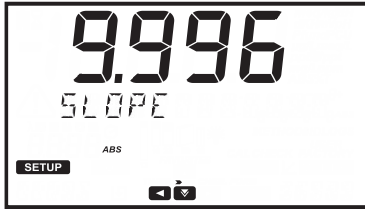
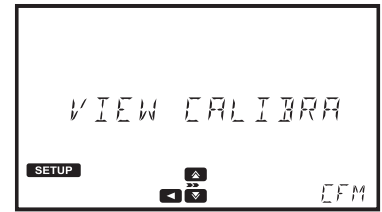

Press the  to return to the previous screen.

### DELETE CALIBRATION

To delete a previous saved calibration use the  or  to select **Delete Calibration**. Press the **CFM** key, and the **YES** key to continue or the **NO** key to return to the Calibration menu.

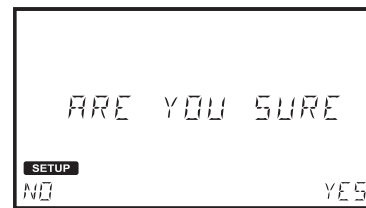

A new calibration is required before the method can be run.



## 7. METHODS

Option: **FACTORY METHODS, USER METHODS, FAVORITE METHODS (if enabled)** and **CREATE NEW**

In order to run an analysis a method needs to be loaded.

Use the  or  key to scroll through the available options.

The number of methods will be displayed on the lower left side of the screen.

Press the  key to return to the main screen.



### 7.1. FACTORY METHODS

Up to 150 factory methods can be stored on the instrument. Use the  or  key to scroll through the methods. To view the methods by ID press the **VIEW** key. Press the **CFM** key to load the selected method.

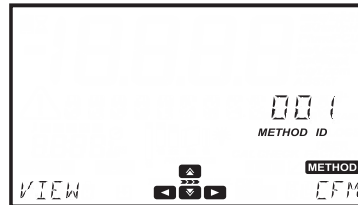

To view the ordering information, method version or to mark the method as a favorite (if enabled) press the  key.

Use the  or  to view the available options.

To view the ordering information press the **CFM** key when "Ordering Info" is displayed.

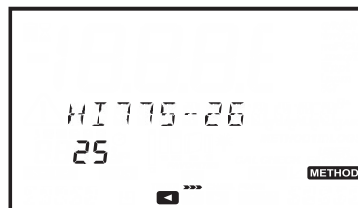

To add a method to the favorites list press the **CFM** key when "Set Favorite" is displayed. If the method is already tagged as a favorite "Clear Favorite" is displayed.



Press the  key to return to the method list.

## 7.2. USER METHODS

Up to 100 user methods can be stored on the instrument. Use the  or  key to scroll through the methods. To view the methods by ID press the **VIEW** key. Press the **CFM** key to load the selected method.

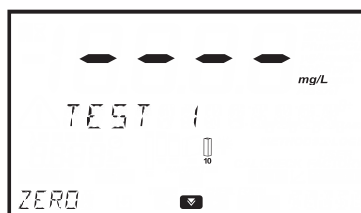

To view additional information press the  key.

Use the  or  to view the available options.

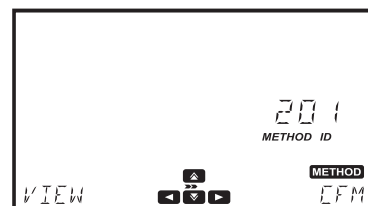

To add a method to the favorites list press the **CFM** key when "Set Favorite" is displayed. If the method is already tagged as a favorite "Clear Favorite" is displayed.



To delete the selected method press the **CFM** key when "Delete" is displayed.



To rename the selected method press the **CFM** key when "Rename" is displayed, see page 39 for additional information.



To export the selected method press the **CFM** key when "Export" is displayed, see page 23 for additional information.



### 7.3. FAVORITE METHODS

Frequently used methods can be tagged as a favorite method, see page 17 for additional information. Favorite methods can be both factory and user methods. Up to 30 methods can be tagged as favorites.

Once a method has been tagged as a favorite it will appear in the Favorite Method list for easy access when the **METHOD** key is pressed. Favorite Methods can also be easily accessed from the main screen by pressing the **▲** key.

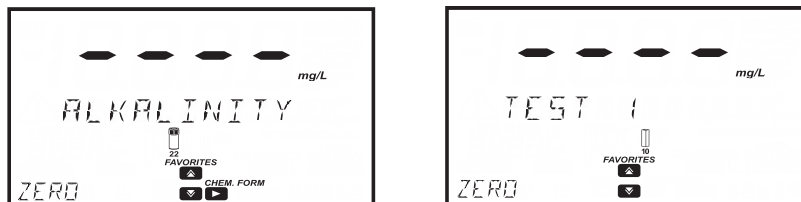

### 7.4. CREATE NEW

This options allows users to develop new user methods.

Press the **CFM** key to create a new method. A series of prompts will guide the user through the process of creating a new method.

Press **NEXT** to proceed to the next setting.

Press **BACK** to return to the previous setting.

#### 7.4.1. METHOD NAME

**Option: Up to 12 alphanumeric characters**

Use the **▲** or **▼** key to select the desired character. Press the **◀** or **▶** key to move across characters.

Press the **NEXT** key to save and continue or the **BACK** key to return to the methods menu.



For more information on the settings and options that are available during method creation, see section 6.4 Method Settings.

After all settings have been entered, press the **CFM** key to create the method. The meter will show "Method Created" before returning to the main screen.

All of these settings can be modified in method settings, see page 28 for additional information.

In order to use the newly created method that reports in a concentration unit a calibration must be done.

A calibration is not required for methods reporting in absorbance, % transmittance or multiwavelength.

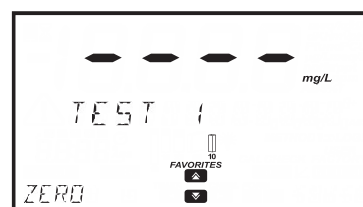
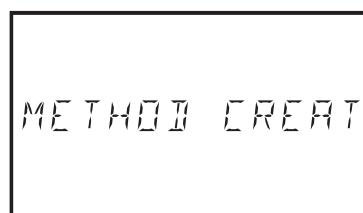

## 8. WARNING AND ERROR MESSAGES

### 8.1. WARNING MESSAGES

FACTORY METHODS FULL	The maximum number of factory methods have been added.
USER METHODS FULL	The maximum number of user methods have been added. At least 1 user method needs to be deleted before a new one can be created.
FAVORITE METHODS FULL	The maximum number of favorite methods have been added.
METHOD MISSING OR CORRUPT	Method file corrupted.
FILE MISSING OR CORRUPT	Log file corrupted.
DISK FULL FACTORY	Factory partition full.
DISK FULL	The maximum number of logs have been saved. At least 1 log needs to be deleted before a new one can be created.
FLASH NOT SUPPORTED	USB flash drive not supported.
FLASH REMOVED	The USB flash drive is missing or cannot be read.
LOG CORRUPTED	Log file corrupted.
NO LIGHT	The Light Source is not functioning properly. Replace the lamp or check the wiring.
LOW LIGHT	The instrument cannot adjust the light level. Please check that the sample does not contain any debris.
LIGHT HIGH	There is too much light to perform a measurement. Please check the preparation of the zero cuvette.
REFERENCE ERROR	There is a problem with the reference channel.
CLOSE THE LID	The lid is not properly closed.
INVERTED CUVETTES	The sample and the zero cuvettes were measured in the wrong order, or there is a problem with the cuvette preparation.
WRONG OR MISSING CUVETTE	Wrong cuvette inserted. The cuvette does not match the one specified in the method.
NOT CALIBRATED	A calibration is required before a user method can be used.
INVALID CALIBRATION	The calculated slope for the calibration curve is outside of allowed range. Please repeat the calibration.
HIGH TEMPERATURE	The internal temperature is higher than 55 °C.
LOW TEMPERATURE	The internal temperature is lower than 0 °C.
LAMP OLD - REPLACE SOON	The lamp life is over recommended maximum period. Consider replacing the lamp.

## 8.2. ERRORS

These types of events are continuously monitored and if one or more occurred it will put the instrument in ERROR mode to avoid unpredictable behavior.



The "Err" is displayed on LCD, followed by the internal code of the error. This screen will block the access to the other screens. If a system error occurs, contact Hanna Technical Support and provide the displayed code.

## 9. ABBREVIATIONS

EPA	US Environmental Protection Agency
°C	degree Celsius
°F	degree Fahrenheit
μg/L	micrograms per liter (ppb)
mg/L	milligrams per liter (ppm)
%T	Percent Transmittance
ABS	Absorbance
ppm	parts per million (mg/L)
ppt	parts per thousand (g/L)
ppb	parts per billion (μg/L)
°f	French degree (Hardness)
°e	English degree (Hardness)
°dH	German degree (Hardness)
meq/L	milliequivalents per liter
meq/kg	milliequivalents per kilogram
PCU	Platinum Cobalt Unit
Pfund	honey color grading scale in millimeters
pH	Negative log of the hydrogen ion activity
mV	Millivolts
dKH	Degrees of Carbonate Hardness

## 10. ACCESSORIES

Code	Description
HI731318	cloth for wiping cuvettes (4 pcs.)
HI731331	22 mm glass cuvettes (4 pcs.)
HI731335N	cap for 22 mm cuvette (4 pcs.)
HI731311	13 mm vials (5 pcs.)
HI731321	16 mm glass cuvettes (4 pcs.)
HI731335N	cap for 16 mm cuvette (4 pcs.)
HI731339P	100 $\mu$ L automatic pipette
HI731340	200 $\mu$ L automatic pipette
HI731341	1000 $\mu$ L automatic pipette
HI731342	2000 $\mu$ L automatic pipette
HI731349P	pipette tip for 100 $\mu$ L graduated pipette (10 pcs.)
HI731350	pipette tip for 200 $\mu$ L graduated pipette (25 pcs.)
HI731351	pipette tip for 1000 $\mu$ L graduated pipette (25 pcs.)
HI731352	pipette tip for 2000 $\mu$ L graduated pipette (4 pcs.)
HI740034P	cap for 100 mL beaker (10 pcs.)
HI740036P	100 mL plastic beaker (10 pcs.)
HI740038	60 mL glass bottle and stopper for dissolved oxygen measurements
HI740142P	1 mL graduated syringe (10 pcs.)
HI740143	1 mL graduated syringe (6 pcs.)
HI740144P	pipette tip for 1 ml graduated syringe (6 pcs.)
HI740157P	plastic refilling pipette (20 pcs.)
HI740220	25 mL glass mixing vial (2 pcs.)
HI740225	60 mL graduated syringe
HI740226	5 mL graduated syringe
HI740227	filter assembly
HI740228	filter discs (25 pcs.)
DEMI-02	demineralizer
HI7408011	16 mm cuvette adapter
HI7408012	10 mm cuvette adapter
HI7408013	13 mm vial adapter
HI75110/15	115 VAC to 15 VDC power adapter, USA plug
HI75220/15	230 VAC to 15 VDC power adapter, European plug
HI93703-50	cuvette cleaning solution (230 mL)
HI93703-55	activated carbon (50 pcs.)

## 11. SPARE PARTS

### 11.1. BATTERY REPLACEMENT

To replace or remove the battery use a Phillips head screwdriver to loosen the screw in the base of the battery cover (a).

Remove the battery cover (b).

Pull the battery out (c).

Always check the polarity when reinserting. The positive (+) sign should be on the top (d).

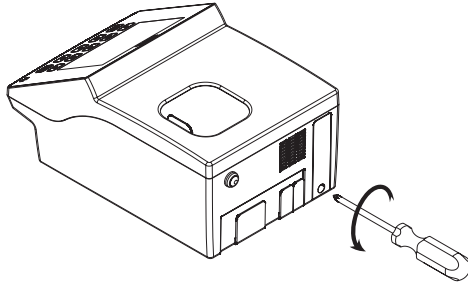

(a)

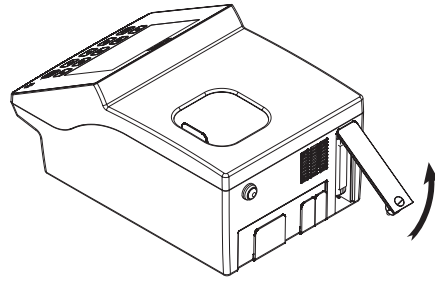

(b)

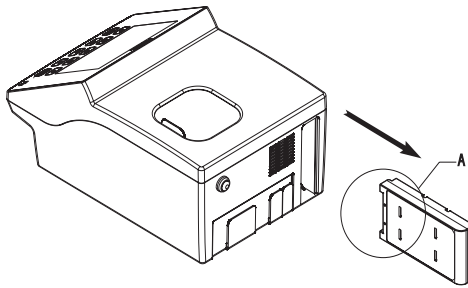

(c)

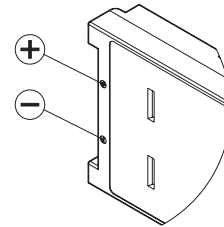

(d)



## 11.2. LAMP REPLACEMENT

Only hold the lamp by the metal holder.

### DO NOT TOUCH THE PINS OR THE QUARTZ GLASS!

Ensure the instrument is off before continuing.

To remove the Tungsten Halogen Lamp follow the steps below.

- (a) Use a Phillips head screwdriver to remove the screw on the lamp cover and remove the cover.
- (b) Remove the two screws in the bottom on the lamp holder using a Phillips head screwdriver.
- (c) Hold the bottom of the lamp holder and slowly pull the lamp out.
- (d) Disconnect the lamp cable before removing the lamp completely.

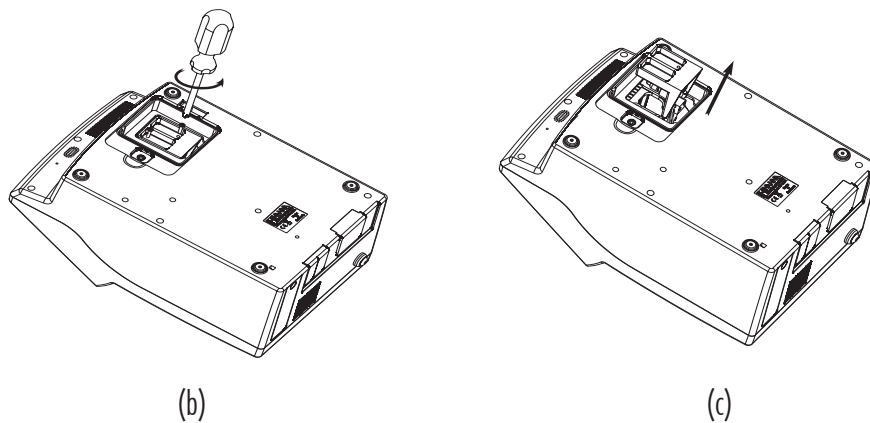
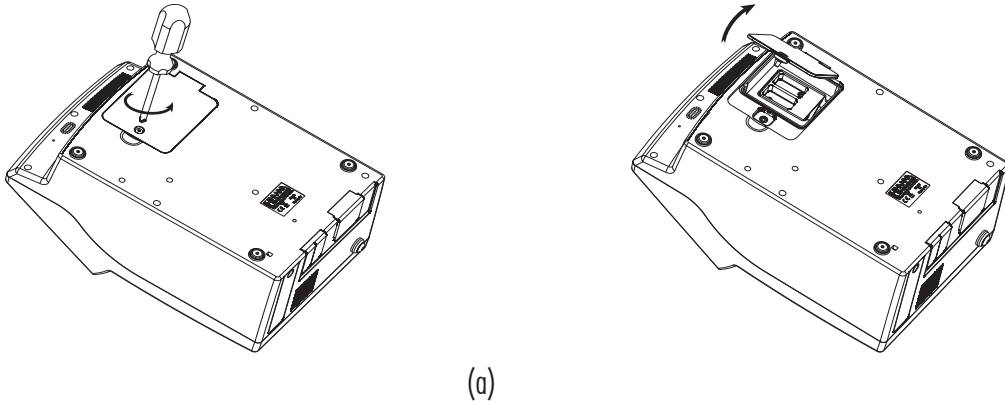

To replace the Tungsten Halogen Lamp follow the steps below:

- (a) Connect the lamp cable to the new lamp
- (b) Align the lamp with the screw holes in the base of the instrument
- (c) Insert the lamp holder into the optical system, making sure the cable is not pinned between the optical system and holder.
- (d) Tighten the two screws in the base of the lamp holder and push the power cable back into the instrument.
- (e) Replace the cover and secure the screw.
- (f) Power on the instrument.

## Recommendations for Users

Before using this product make sure that they are entirely suitable for your specific application and for the environment in which they are used.

Operation of these instruments may cause interferences to other electronic equipment. Take all necessary steps to correct such interferences. Any variation introduced by the user to the supplied equipment may degrade the instruments EMC performance.

For yours and the instrument safety do not use or store the instrument in hazardous environments.

## Certification

This product conforms with all **European Directives** for Laboratory Devices.



RoHS  
compliant

**Disposal of Electrical & Electronic Equipment.** The product should not be treated as household waste. Instead hand it over to the appropriate collection point for the recycling of electrical and electronic equipment which will conserve natural resources.

**Disposal of waste batteries.** This product contains batteries, do not dispose of them with other household waste. Hand them over to the appropriate collection point for recycling.

Ensuring proper product and battery disposal prevents potential negative consequences for the environment and human health, which may be caused by inappropriate handling. For more information, contact your city, your local household waste disposal service, the place of purchase or go to [www.hannainst.com](http://www.hannainst.com).



## Warranty

The **HI801 iris spectrophotometer** is warranted for two years against defects in workmanship and materials when used for its intended purpose and maintained according to instructions. This warranty is limited to repair or replacement free of charge. Damage due to accidents, misuse, tampering or lack of prescribed maintenance is not covered. If service is required, contact your local Hanna Instruments Office. If under warranty, report the model number, date of purchase, serial number and the nature of the problem. If the repair is not covered by the warranty, you will be notified of the charges incurred. If the instrument is to be returned to Hanna Instruments, first obtain a Returned Goods Authorization number from the Technical Service department and then send it with shipping costs prepaid. When shipping any instrument, make sure it is properly packed for complete protection.

## World Headquarters

Hanna Instruments Inc.  
Highland Industrial Park  
584 Park East Drive  
Woonsocket, RI 02895 USA  
[www.hannainst.com](http://www.hannainst.com)

## Local Office

Hanna Instruments USA  
Highland Industrial Park  
584 Park East Drive  
Woonsocket, RI 02895 USA  
Phone: 800.426.6287  
Fax: 401.765.7575  
e-mail: [tech@hannainst.com](mailto:tech@hannainst.com)